

PRODUCT CATALOG



EXPERIENCE THE *Southern* DIFFERENCE

2031 KING ST EXT, CHARLESTON SC 29405

CALL (843)744-6281 VISIT SoLUMBER.COM

CONTENTS

Backbands.....	28-29	Lattice.....	46
Back Mouldings.....	47	Mullion.....	43
Base Cap Mouldings.....	32-34	Nosings.....	42
Base Mouldings.....	30-31	Panel Mouldings.....	35
Beaded Stock.....	25-27	Pediment Cap.....	19
Beauti Mouldings.....	36	Picture Moulding.....	35
Bed Mouldings.....	12-13	Porch Flooring.....	67-68
Brick Mouldings.....	49-50	Post Caps.....	81-85
Cabinet Moulding.....	35	Quarter Round Mouldings.....	40
Casings.....	20-24	S1S2E (Surface 1 Face and 2 Edges).....	104
Ceilings & Walls.....	57-61	S4S.....	100-103
Chair Rails.....	37	S4S (Exterior Use).....	88-99
Chamfer Strip.....	46	Sapele Screen Doors.....	106
Column Base Moulding.....	51	Screen Moulding.....	46
Corner Moulding.....	36	Shingle Mouldings.....	47
Cove Mouldings.....	14-19	Shoe Moulding.....	34
Crown Mouldings.....	4-11	Sidings.....	51-56
Decking.....	69-70	Sill Nosing.....	49
Dimensional IPE.....	71	Stair Nosing.....	63
Drip Caps.....	48	Stair Rails.....	63-65
Exterior Rails.....	74-77	Stair Treads.....	62
Fiberboards.....	105	Stools.....	43-45
Flooring.....	66	Stops.....	38-39
Full Round Moulding.....	41	Treated Balusters.....	78-80
Glass Bead.....	46	Window Cap.....	48
Half Round Mouldings.....	41		



TruExterior[®]
Siding & Trim



TRUE BEAUTY AND VERSATILITY

TruExterior[®] 5/8" Lap Siding is unlike any other exterior siding. It has the versatility and toughness to stand up to extreme conditions, offering beauty with little maintenance. It's a bold choice that offers deep shadow lines and curb appeal that's hard to resist.

[TruExterior.com](https://www.TruExterior.com)



MAKE LIVING ON THE COAST EVEN MORE BEAUTIFUL

Marvin's coastal solution product offerings demonstrate the same beautiful design, expert craftsmanship, and thoughtful features as their other products. In harsh coastal conditions, you can rely on Marvin windows and doors to stand up to the unpredictable elements near the coast.

MARVIN® 

marvin.com





SEAMLESS INNOVATIVE SOLUTIONS

Leading building solutions. Engineered for excellence.

Our **Trus Joist**[®] suite of products are designed to work together seamlessly to provide the innovative solutions you need for your project – from floor beams and joists, to wall studs and roof rafters. Create consistent and reliable structural framing with confidence by integrating **TJI**[®] Joists, **Parallam**[®] PSL, **Microllam**[®] LVL, and **TimberStrand**[®] LSL.



**For more information about our innovative wood products,
go to [Weyerhaeuser.com/WoodProducts](https://www.Weyerhaeuser.com/WoodProducts)**

Trus Joist[™]
Weyerhaeuser

 **Weyerhaeuser**

 Weyerhaeuser, Microllam, Parallam, TimberStrand, TJ, TJI, and Trus Joist are registered trademarks of Weyerhaeuser NR Company. © 2022 Weyerhaeuser NR Company. All Rights Reserved.

CROWN MOULDINGS

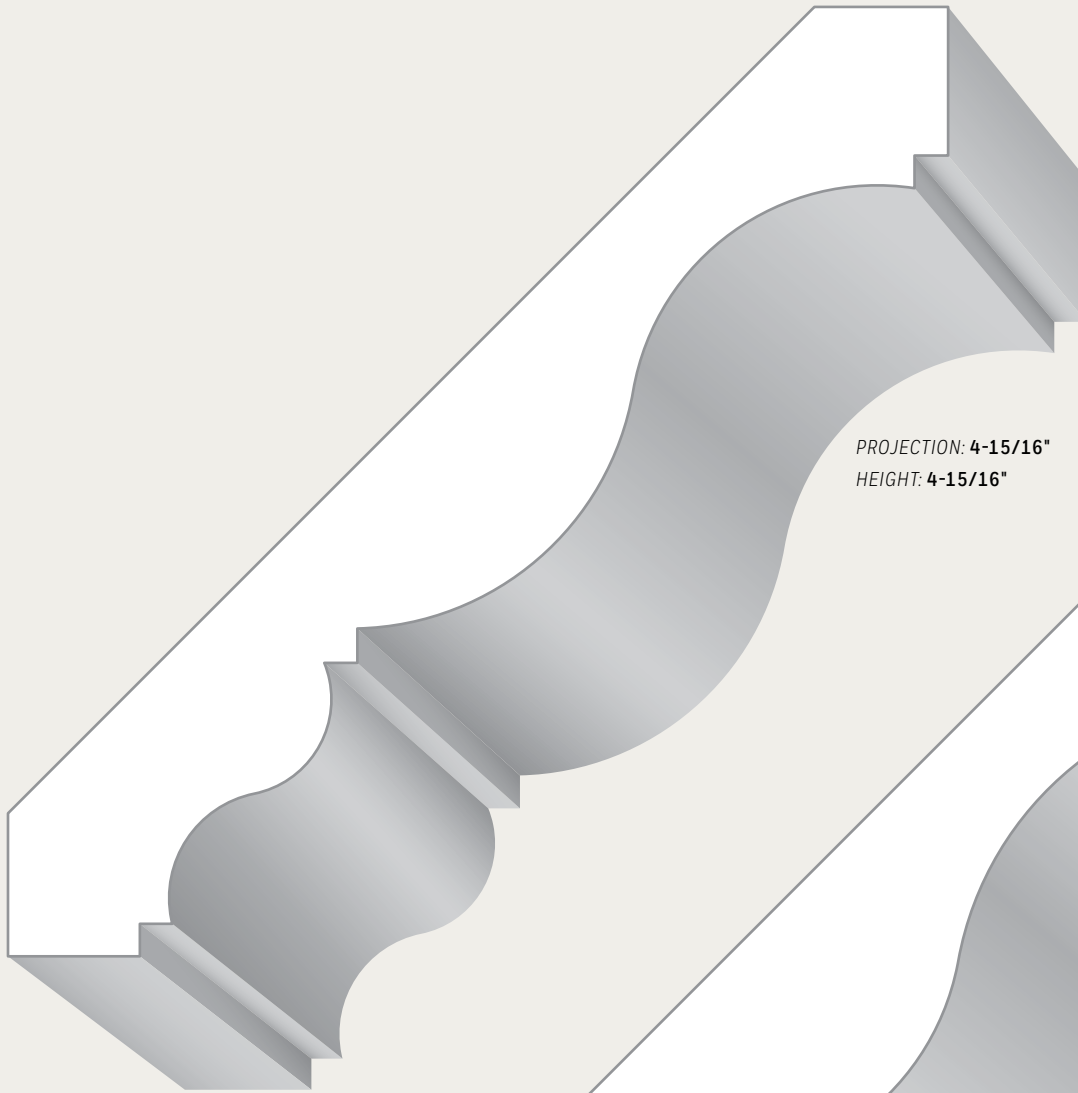

PROJECTION: 4-15/16"
HEIGHT: 4-15/16"

6-7/8" Multi Look Crown Moulding

 **SL7503**

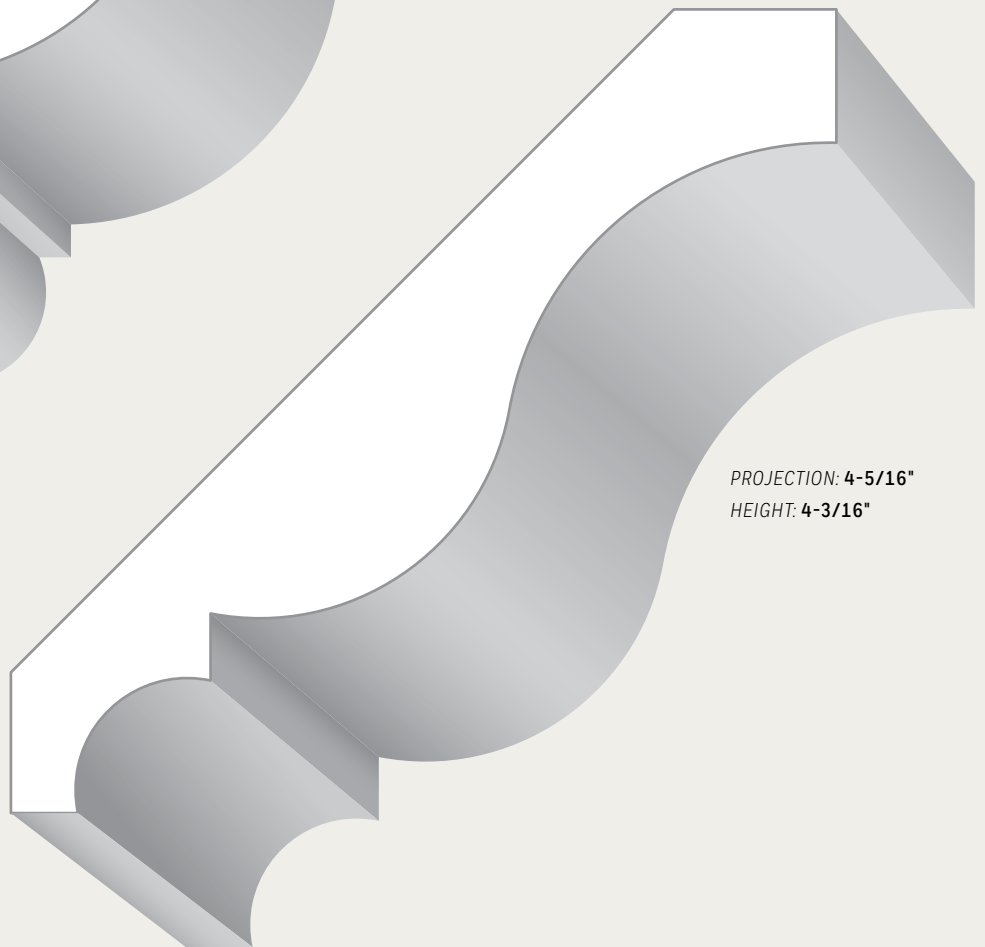

PROJECTION: 4-5/16"
HEIGHT: 4-3/16"

6" Net Heavy Crown Moulding with Cove

 **SL6HCP**

 **SL6HCT**



CROWN MOULDINGS

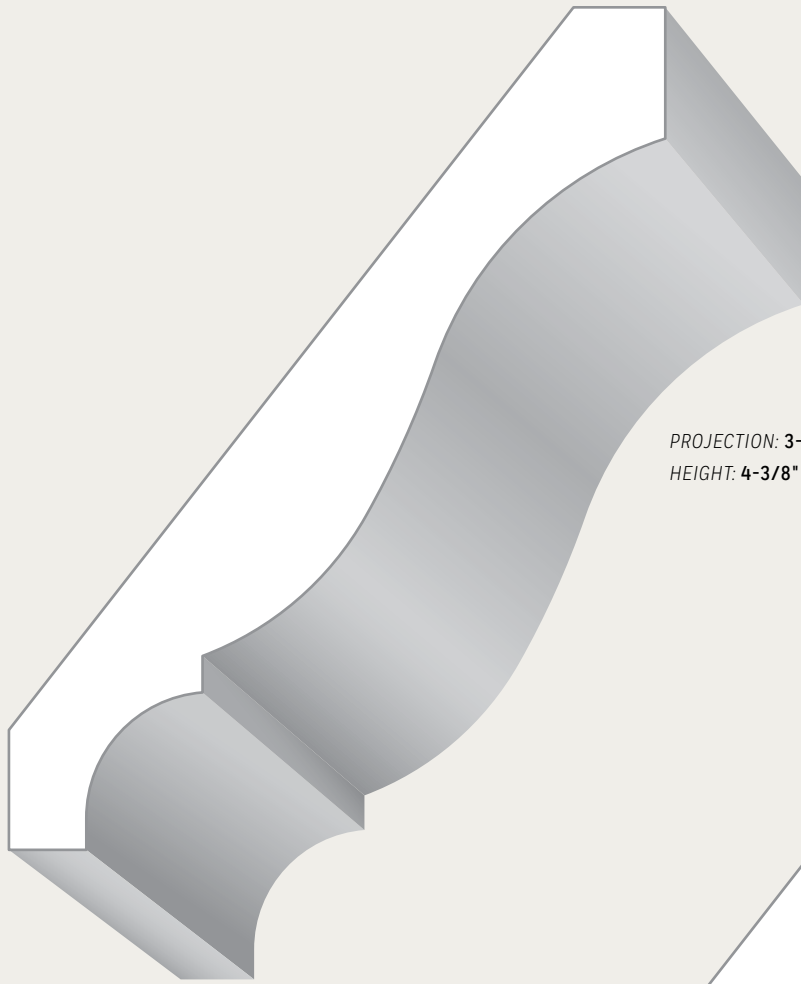

PROJECTION: 3-7/16"
HEIGHT: 4-3/8"

5-5/8" Crown Moulding with Cove

 **SL558CP**

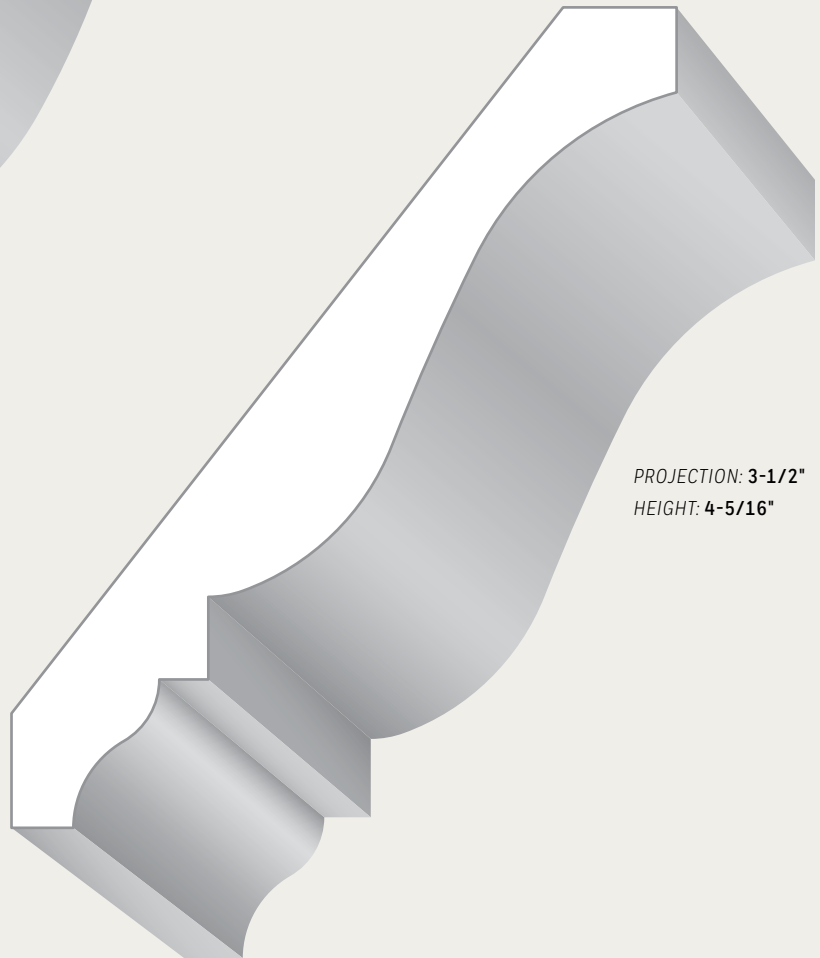

PROJECTION: 3-1/2"
HEIGHT: 4-5/16"

5-1/2" Crown Moulding with PG Edge

 **SL512CPG**



ELITE TREATED[®]
AND PRIMED



YELLOW
PINE



TREATED
PINE



RED
OAK



PRIMED
FJ PINE



MDF
PRIMED



POPLAR



SAPELE



PVC



FLEX
MOULDING

CROWN MOULDINGS

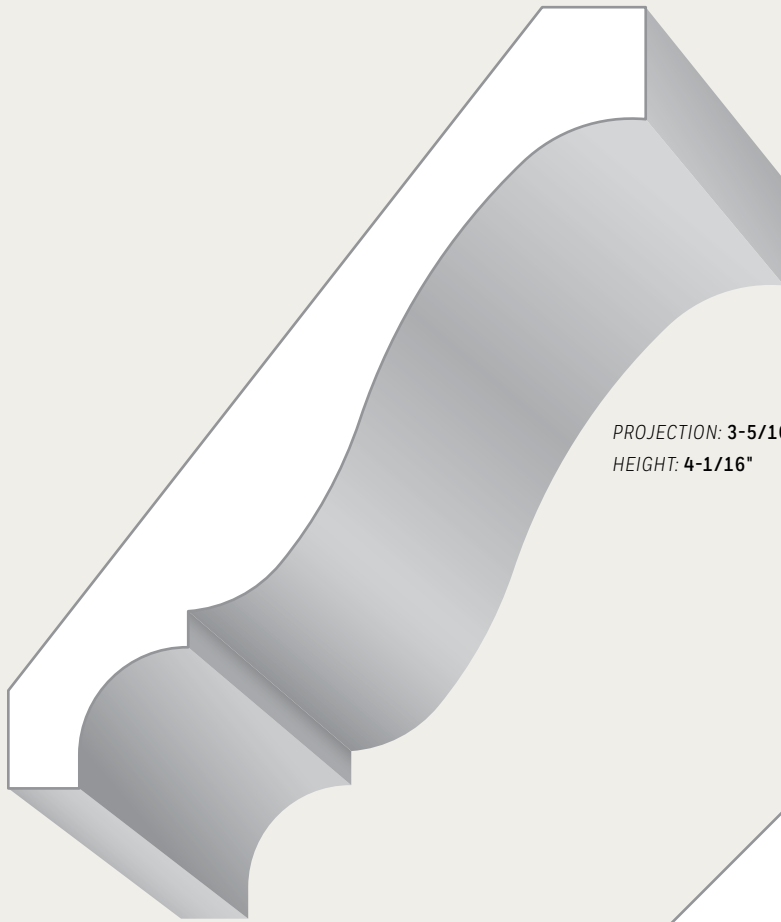

PROJECTION: 3-5/16"
HEIGHT: 4-1/16"

5-1/4" Crown Moulding with Cove



SL514CP



SL514T

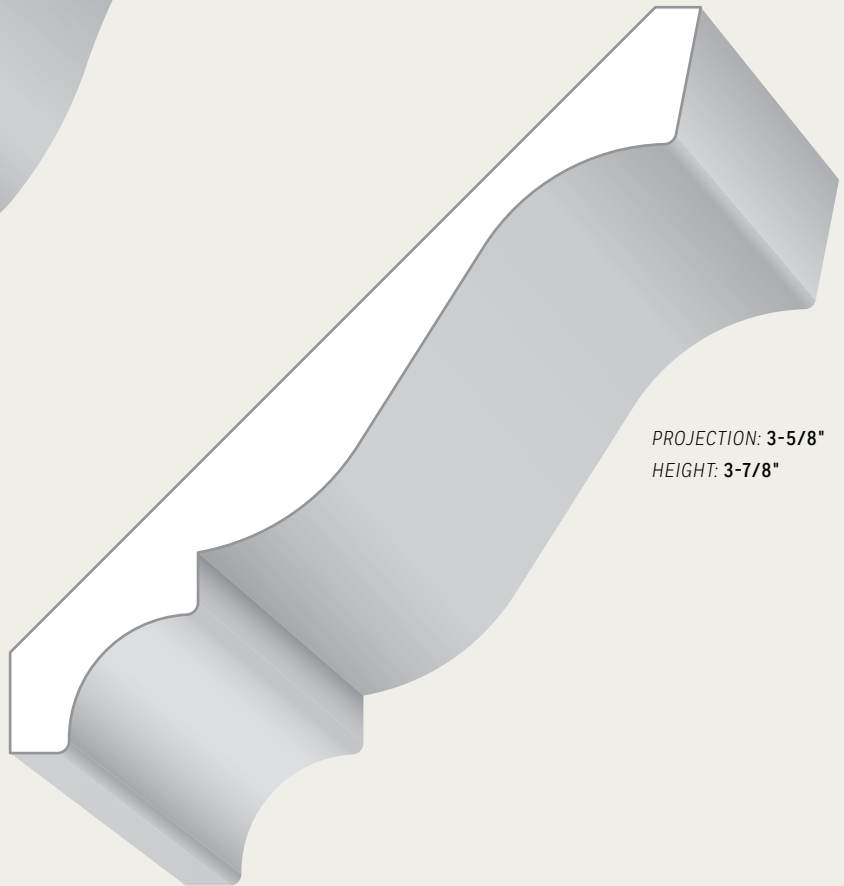

PROJECTION: 3-5/8"
HEIGHT: 3-7/8"

5-1/4" MDF Crown Moulding with Cove – 16'



MDF45A



CROWN MOULDINGS

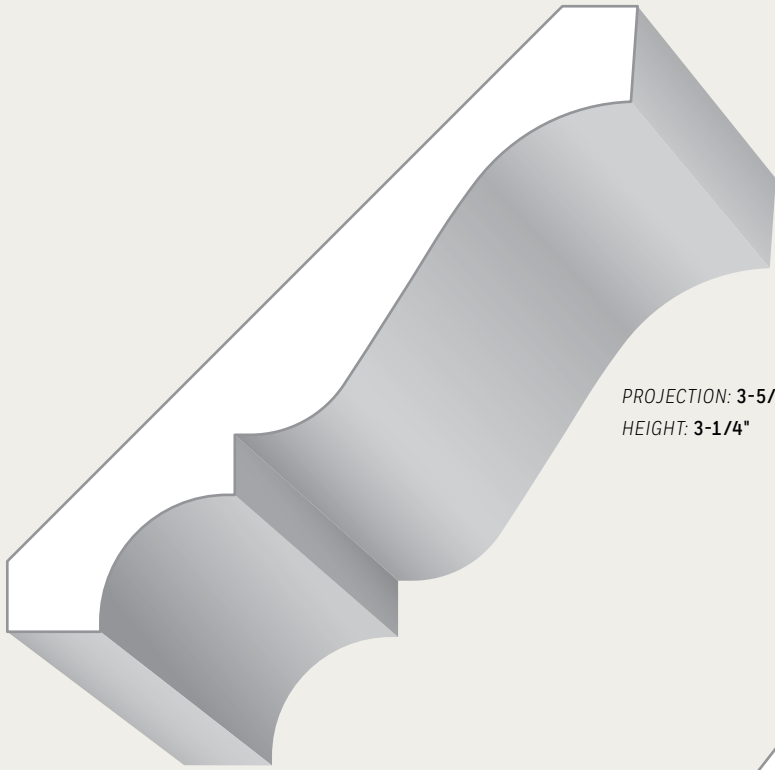

PROJECTION: 3-5/16"
HEIGHT: 3-1/4"

4-5/8" MDF Crown Moulding with Cove - 16'

 **MDF47**

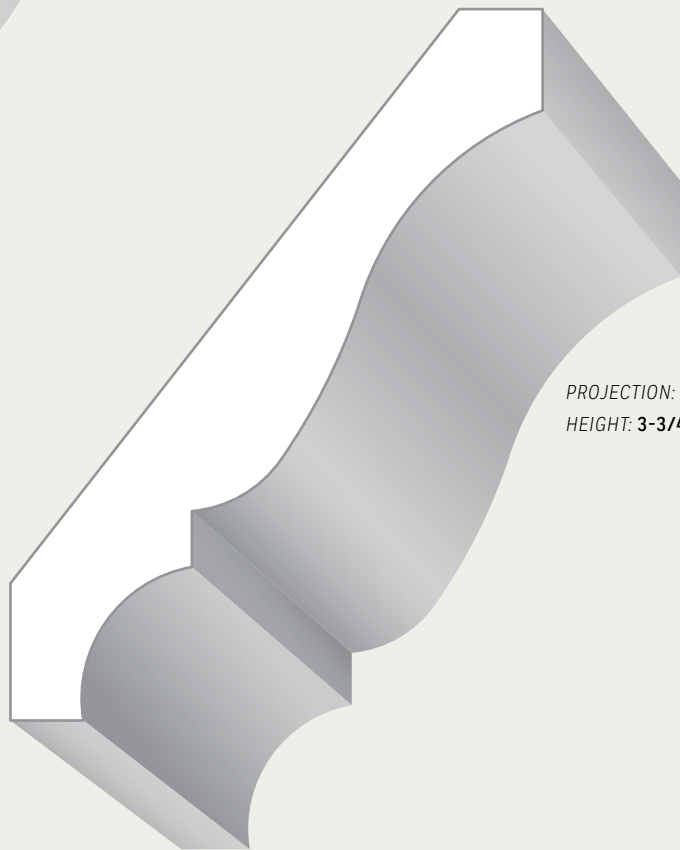

PROJECTION: 2-13/16"
HEIGHT: 3-3/4"

4-5/8" Crown Moulding with Cove

 **SL47P**
 **SL47T**



ELITE TREATED[®]
AND PRIMED



YELLOW
PINE



TREATED
PINE



RED
OAK



PRIMED
FJ PINE



MDF
PRIMED



POPLAR



SAPELE



PVC



FLEX
MOULDING

CROWN MOULDINGS

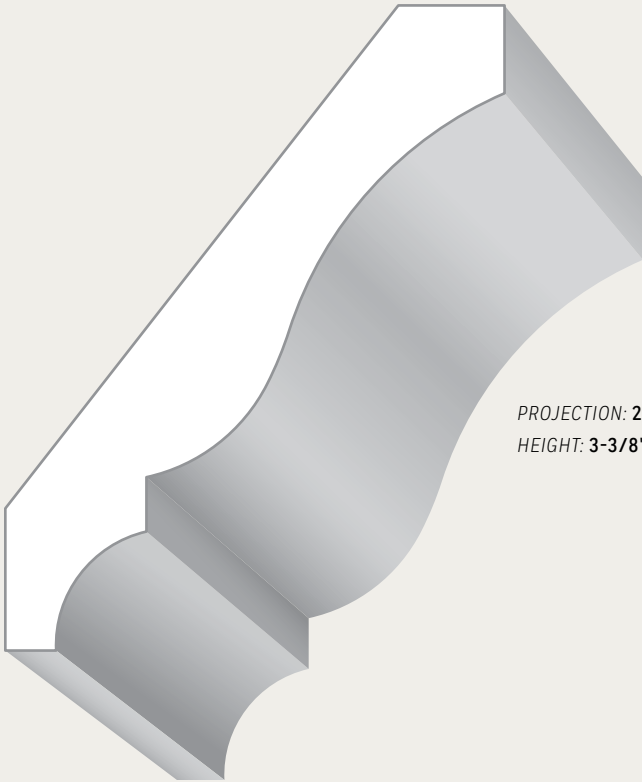

PROJECTION: 2-5/8"
HEIGHT: 3-3/8"

4-1/4" Crown Moulding with Cove

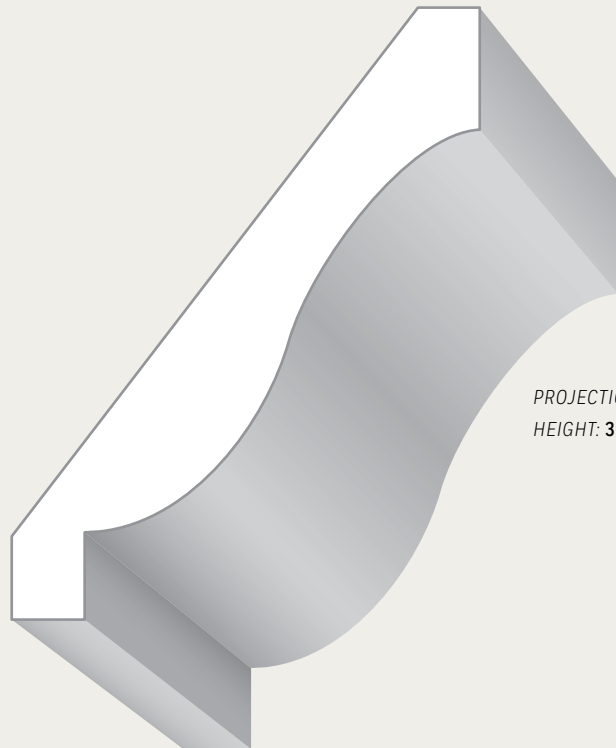

PROJECTION: 2-1/2"
HEIGHT: 3-3/16"

4" Crown Moulding No Cove



SL4CT



CROWN MOULDINGS

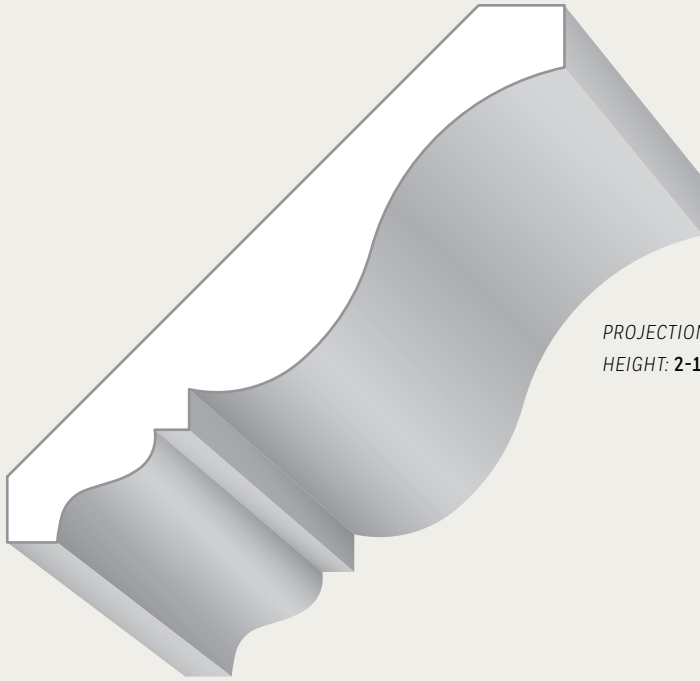

PROJECTION: 2-15/16"
HEIGHT: 2-13/16"

4" Crown Moulding with PG Edge

 **SL4CPGP**

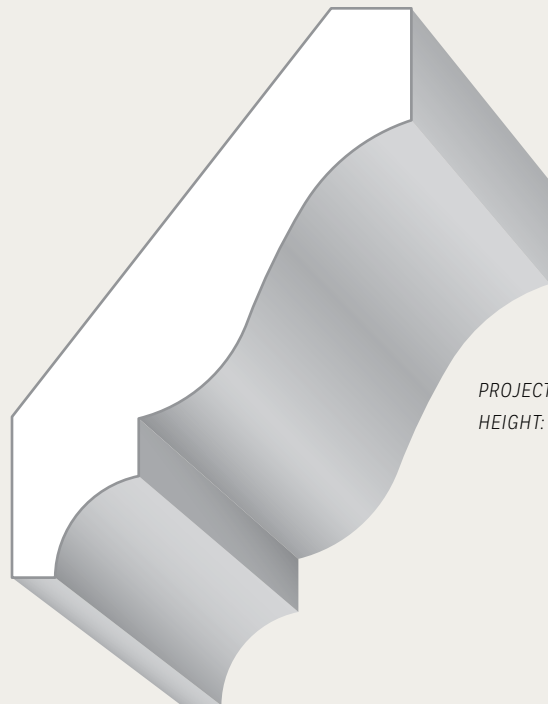

PROJECTION: 2-1/8"
HEIGHT: 3"

3-5/8" Crown Moulding with Cove

 **SL49P**
 **SL49T**



ELITE TREATED®
AND PRIMED



YELLOW
PINE



TREATED
PINE



RED
OAK



PRIMED
FJ PINE



MDF
PRIMED



POPLAR



SAPELE



PVC



FLEX
MOULDING

CROWN MOULDINGS

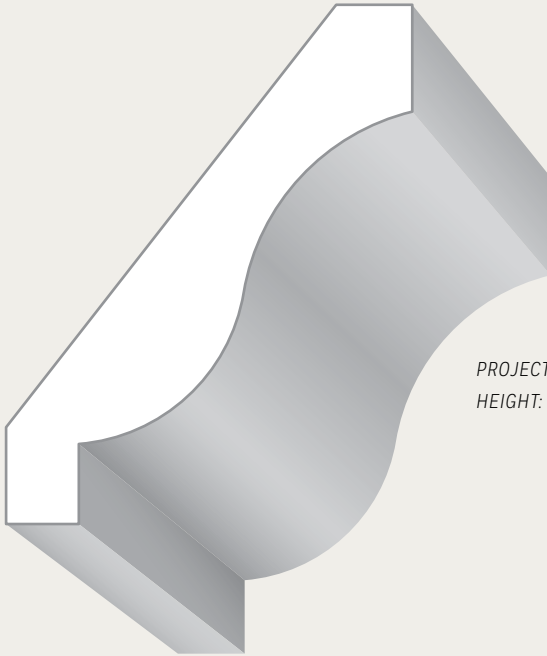

PROJECTION: 2-1/8"
HEIGHT: 2-3/4"

3-1/2" Crown Moulding No Cove



SL312CT

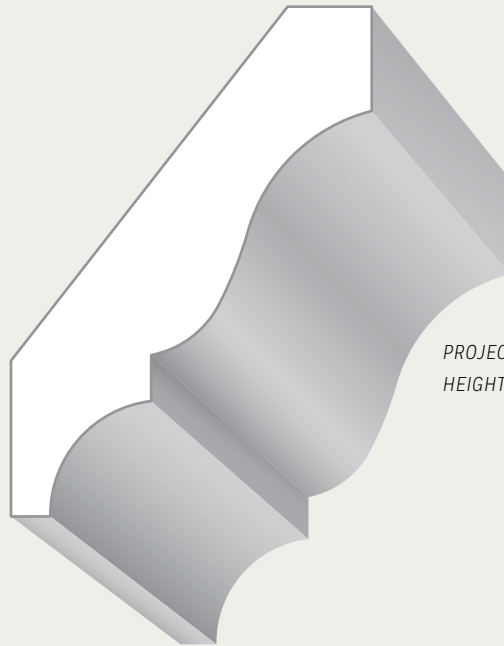

PROJECTION: 1-7/8"
HEIGHT: 2-11/16"

3-1/4" Crown Moulding with Cove



SL51P



CROWN MOULDINGS

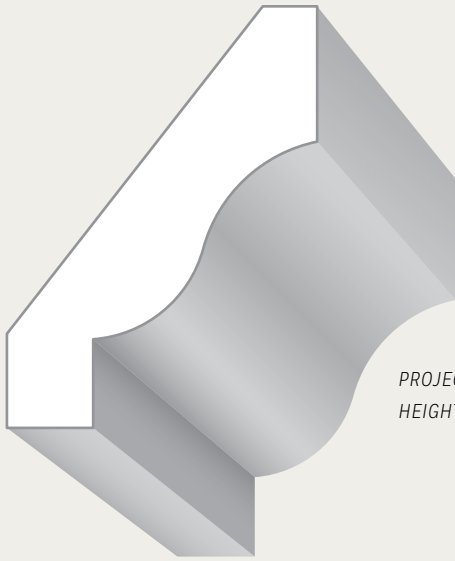

PROJECTION: 1-5/8"
HEIGHT: 2-3/16"

2-3/4" Crown Moulding No Cove



SL234CT

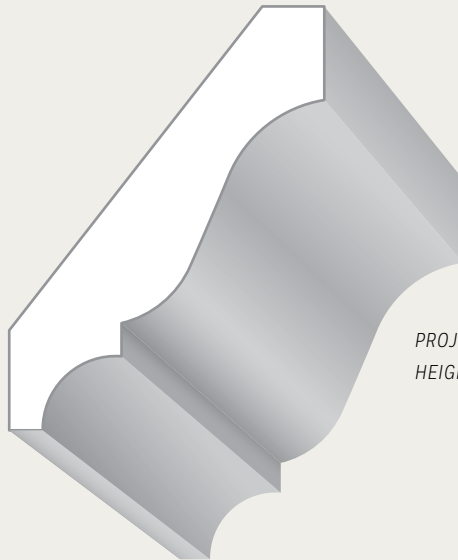

PROJECTION: 1-11/16"
HEIGHT: 2-1/4"

2-3/4" Crown Moulding with Cove



SL52P

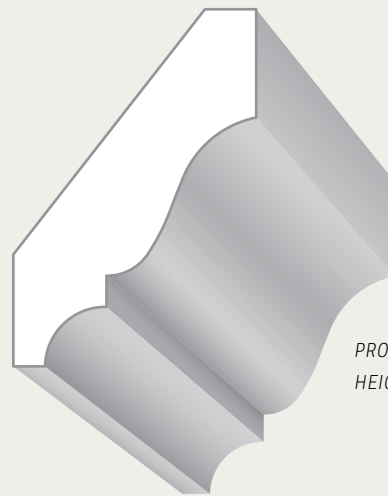

PROJECTION: 1-1/4"
HEIGHT: 1-7/8"

2-1/4" Crown Moulding with Cove



SL54P



SL54T



ELITE TREATED®
AND PRIMED



YELLOW
PINE



TREATED
PINE



RED
OAK



PRIMED
FJ PINE



MDF
PRIMED



POPLAR



SAPELE



PVC



FLEX
MOULDING

BED MOULDINGS

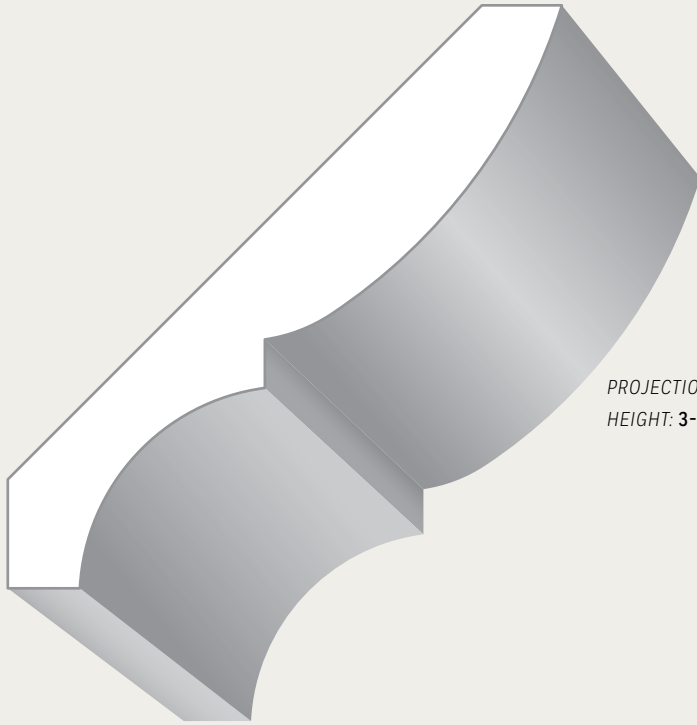

PROJECTION: 2-7/8"
HEIGHT: 3-1/16"

4-1/4" Bed Moulding



SL414T

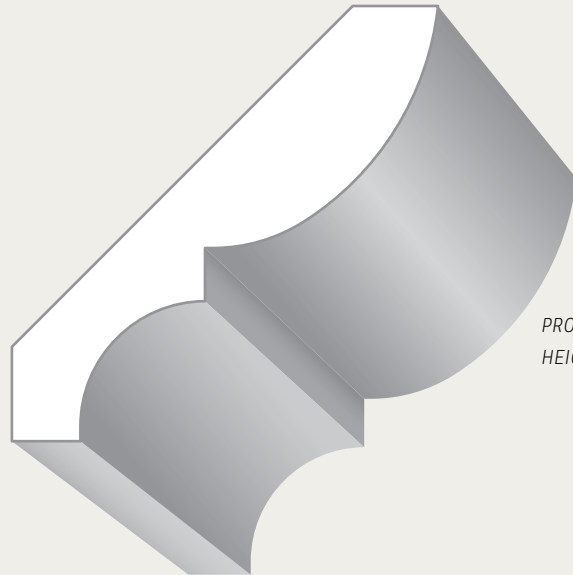

PROJECTION: 2-1/4"
HEIGHT: 2-5/16"

3-1/4" Bed Moulding



SL66P



SL66T



BED MOULDINGS

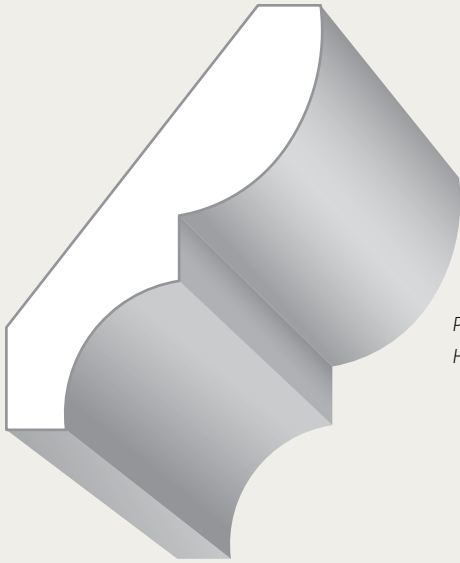

PROJECTION: 1-11/16"
HEIGHT: 2-1/4"

2-3/4" Bed Moulding



PROJECTION: 1-5/16"
HEIGHT: 1-7/8"

2-1/4" Bed Moulding

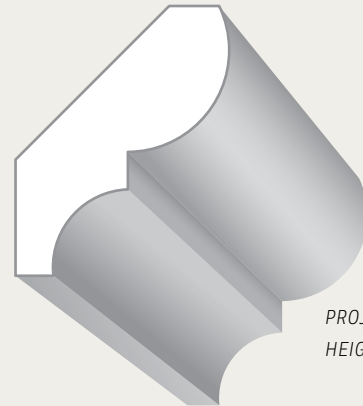

PROJECTION: 1-1/8"
HEIGHT: 1-7/16"

1-3/4" Bed Moulding



COVE MOULDINGS

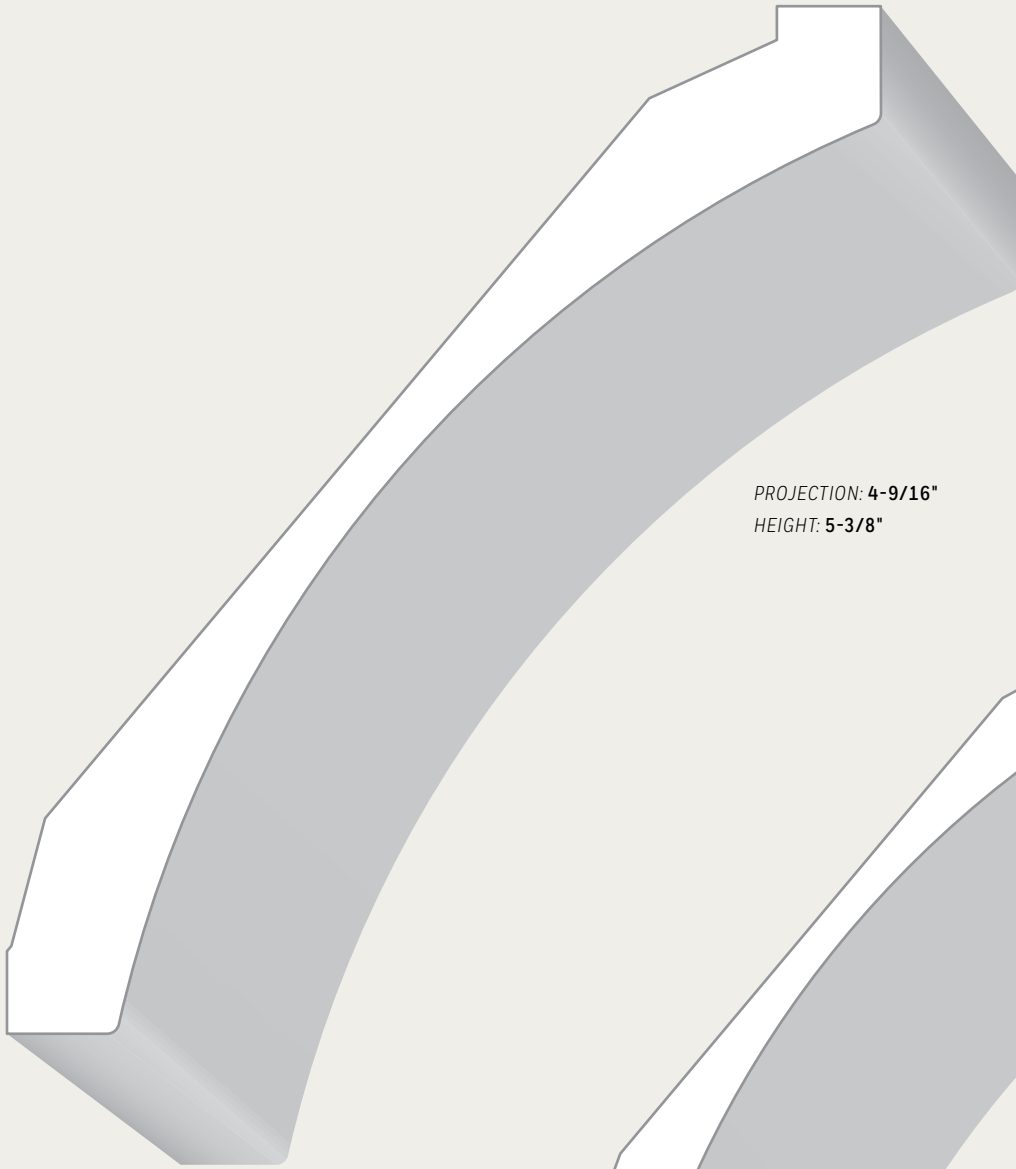

PROJECTION: 4-9/16"
HEIGHT: 5-3/8"

7" MDF Cove Moulding - 16'

 **MDF505**



PROJECTION: 3-1/2"
HEIGHT: 4"

5-1/4" MDF Cove Moulding - 16'

 **MDF653**



COVE MOULDINGS

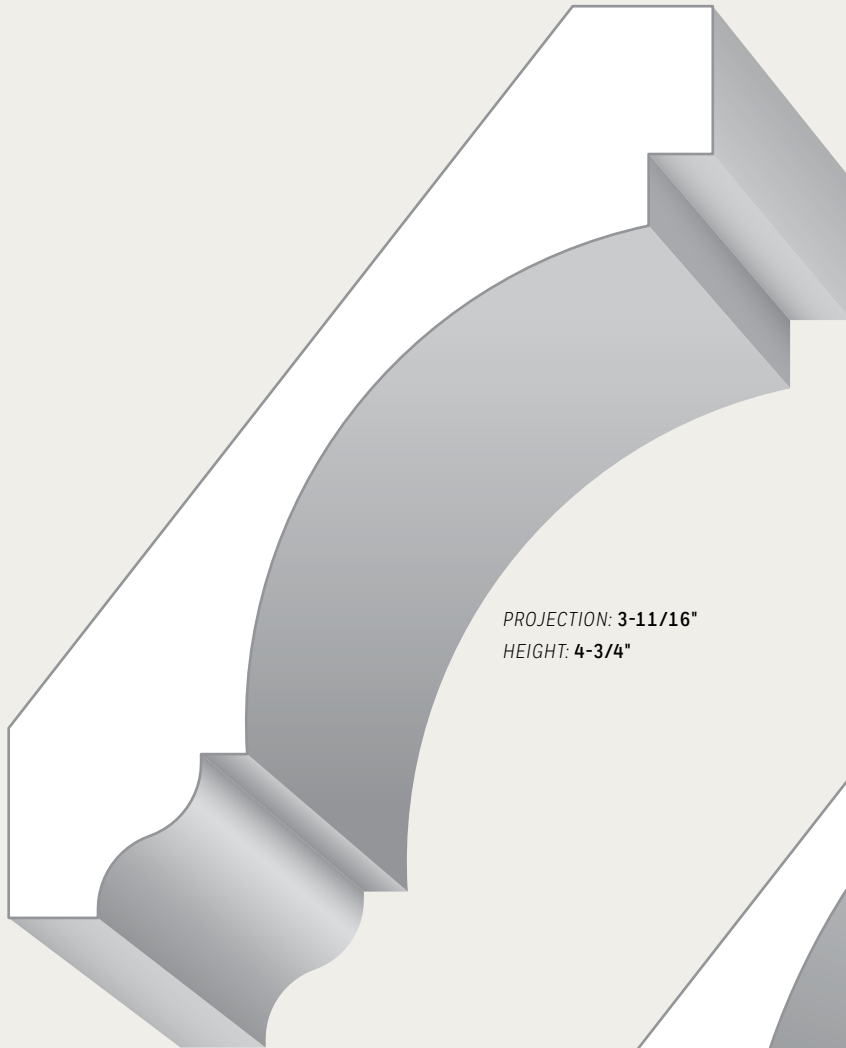

PROJECTION: 3-11/16"
HEIGHT: 4-3/4"

6" Cove Moulding with PG Edge

 **SL6PGC**

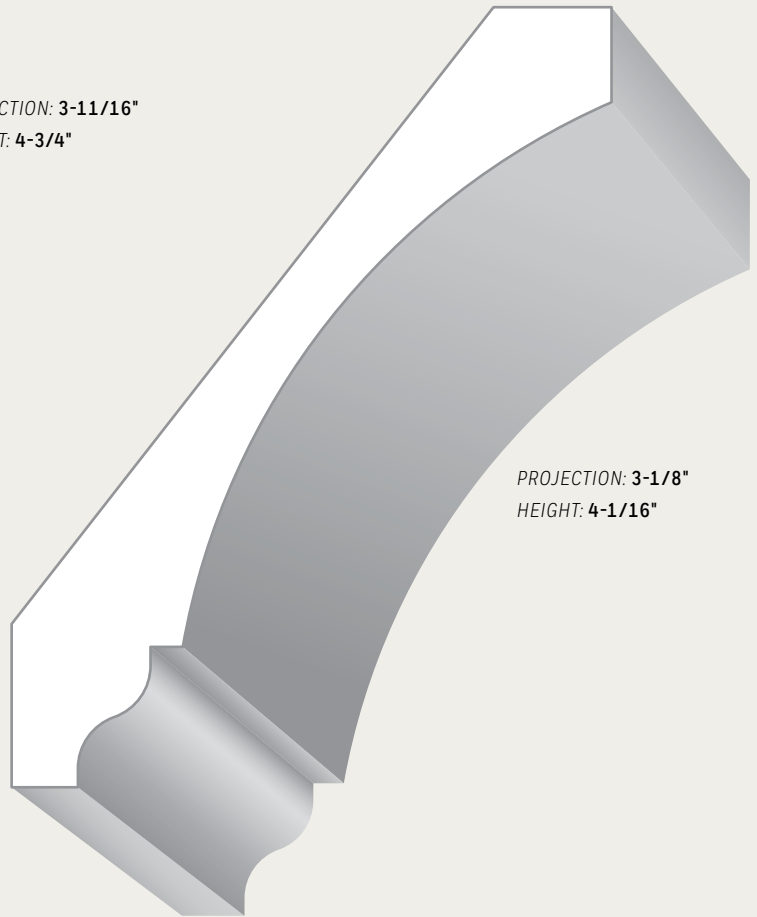

PROJECTION: 3-1/8"
HEIGHT: 4-1/16"

5-1/4" Cove Moulding with PG Edge

 **SL514PGC**

 **SL514PGCT**



ELITE TREATED®
AND PRIMED



YELLOW
PINE



TREATED
PINE



RED
OAK



PRIMED
FJ PINE



MDF
PRIMED



POPLAR



SAPELE



PVC



FLEX
MOULDING

COVE MOULDINGS

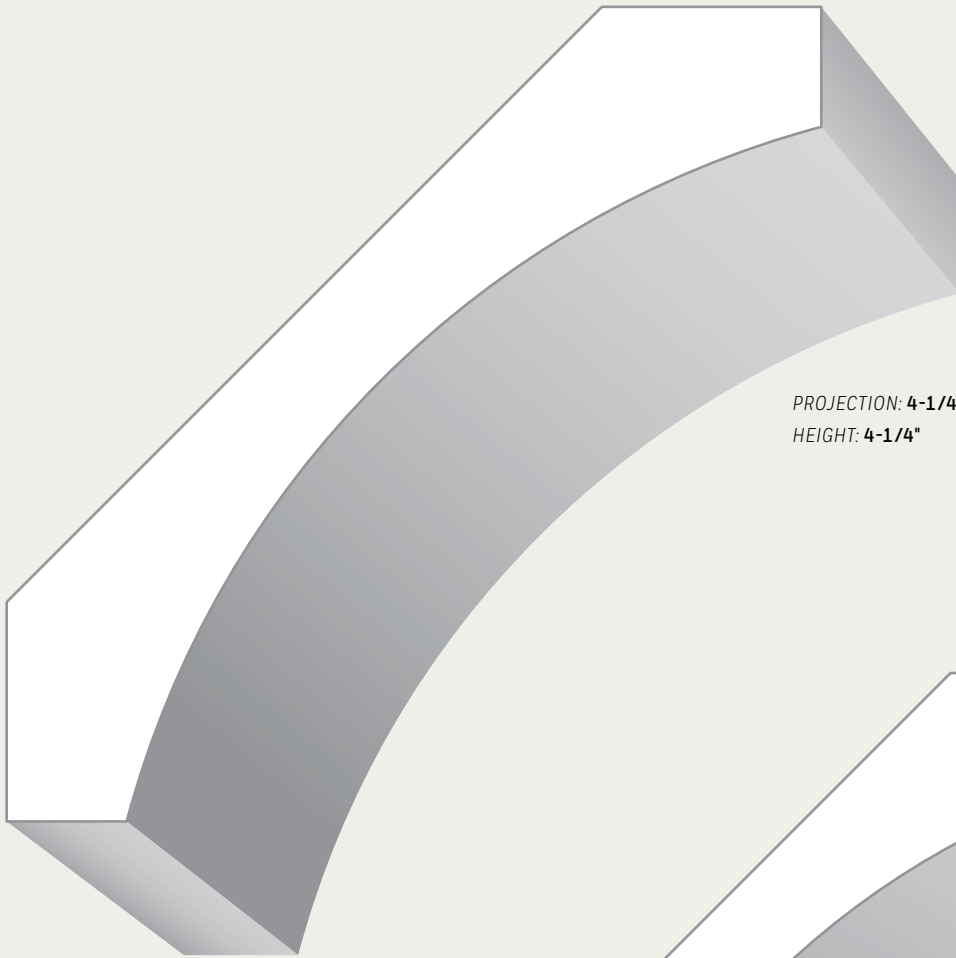

PROJECTION: 4-1/4"
HEIGHT: 4-1/4"

6" Cove Moulding



SL6PCP



SL6PCT

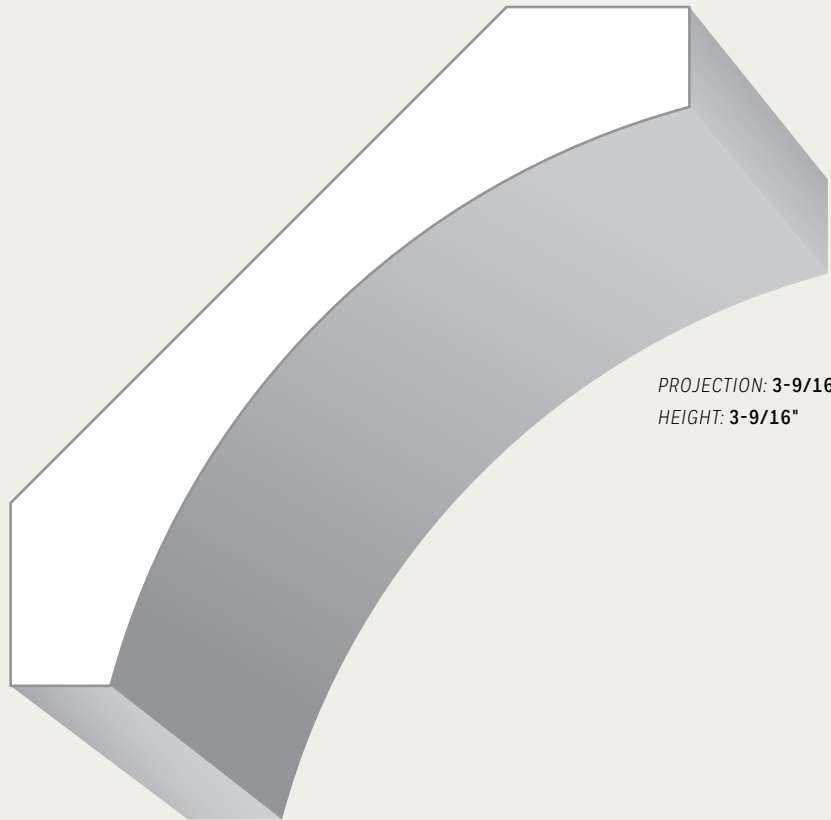

PROJECTION: 3-9/16"
HEIGHT: 3-9/16"

5" Cove Moulding



SL5PCP



COVE MOULDINGS

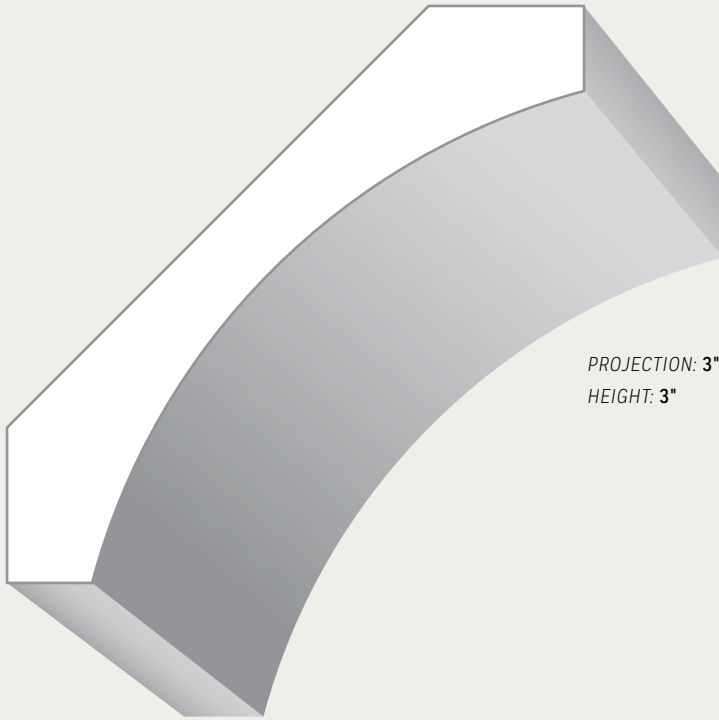

PROJECTION: 3"
HEIGHT: 3"

4-1/4" Cove Moulding



SL414PCP



SL414PCT

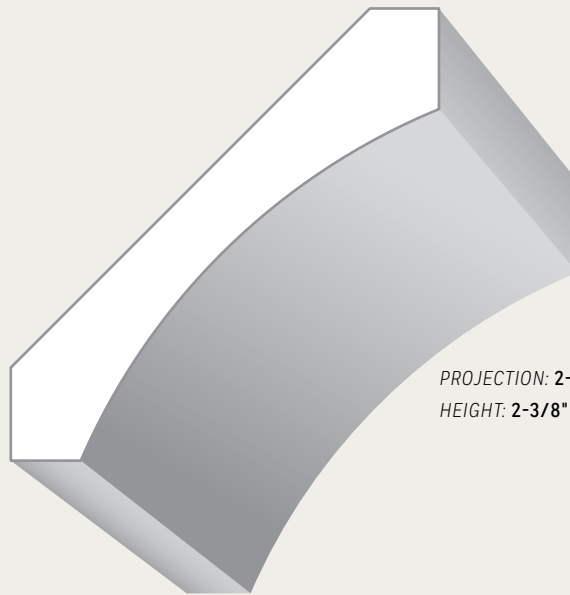

PROJECTION: 2-1/4"
HEIGHT: 2-3/8"

3-1/4" Cove Moulding



SL81P



SL81T



ELITE TREATED[®]
AND PRIMED



YELLOW
PINE



TREATED
PINE



RED
OAK



PRIMED
FJ PINE



MDF
PRIMED



POPLAR



SAPELE



PVC



FLEX
MOULDING

COVE MOULDINGS

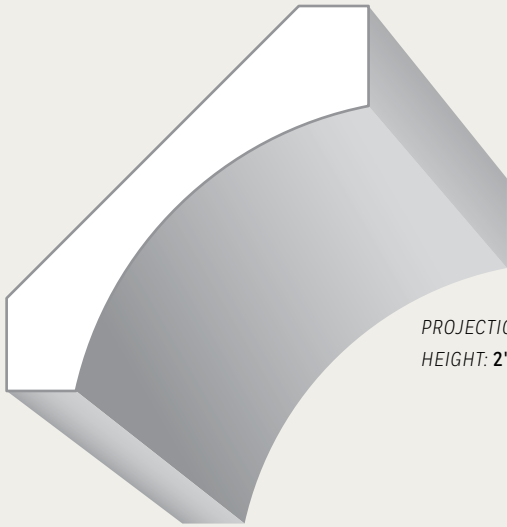

PROJECTION: 1-7/8"
HEIGHT: 2"

2-3/4" Cove Moulding

 **SL82P**

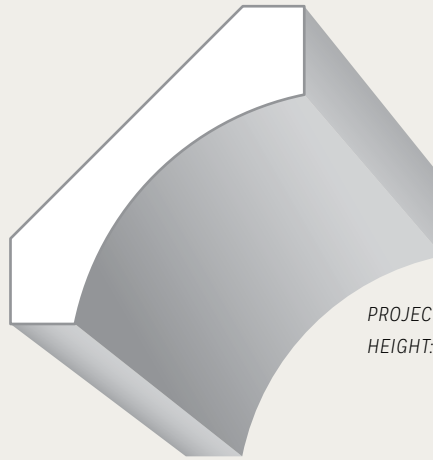

PROJECTION: 1-9/16"
HEIGHT: 1-11/16"

2-1/4" Cove Moulding

 **SL84P**
 **SL84T**

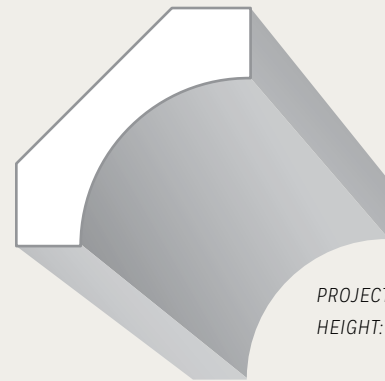

PROJECTION: 1-1/4"
HEIGHT: 1-1/4"

1-3/4" Cove Moulding

 **SL85P**



COVE MOULDINGS

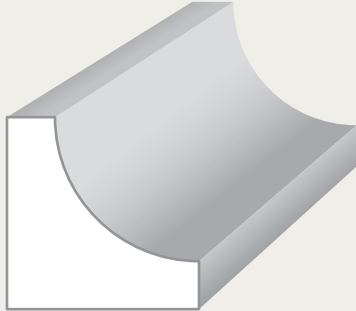

1" Cove Moulding

-  **SL54CYP**
-  **SL54CT**

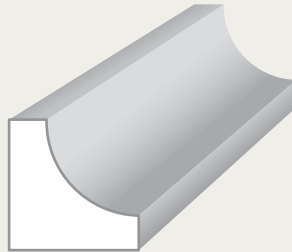

3/4" Cove Moulding

-  **SL100YP**
-  **SL100T**
-  **SL100O**
-  **SL100F - 12'**

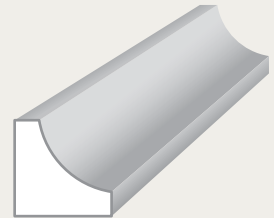

1/2" Cove Moulding

-  **SL101YP**

PEDIMENT CAP

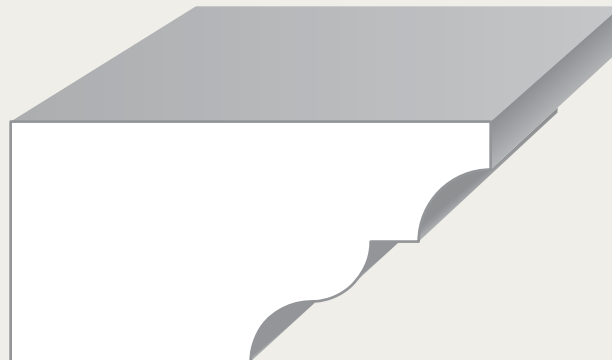

1-1/4" x 2-1/2" Pediment Cap

-  **SLPCP**



ELITE TREATED[®]
AND PRIMED



YELLOW
PINE



TREATED
PINE



RED
OAK



PRIMED
FJ PINE



MDF
PRIMED



POPLAR



SAPELE



PVC



FLEX
MOULDING

CASINGS

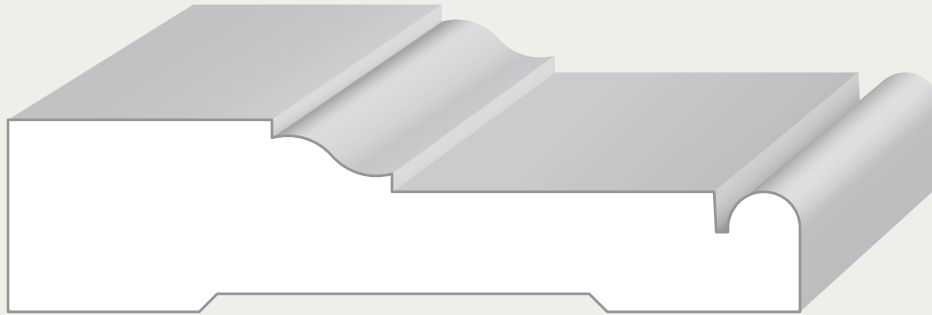

1" x 4-1/8" Beaded Wilbur Casing

 **SL4BWCP**

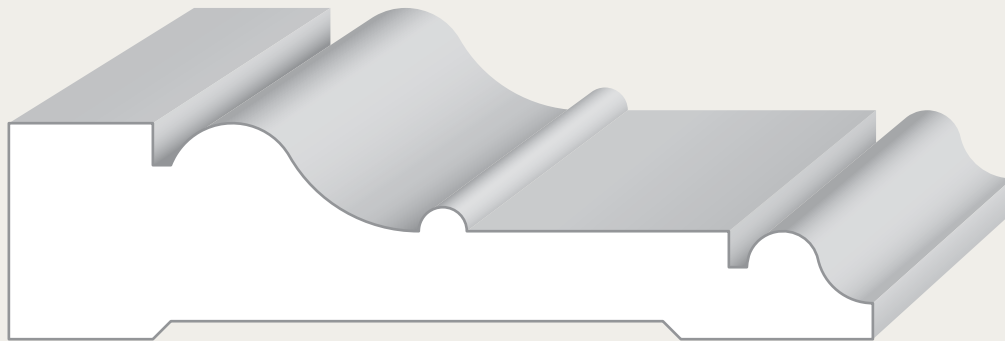

1-1/8" x 4-1/2" Casing with Backband

 **SL412WBP**



CASINGS

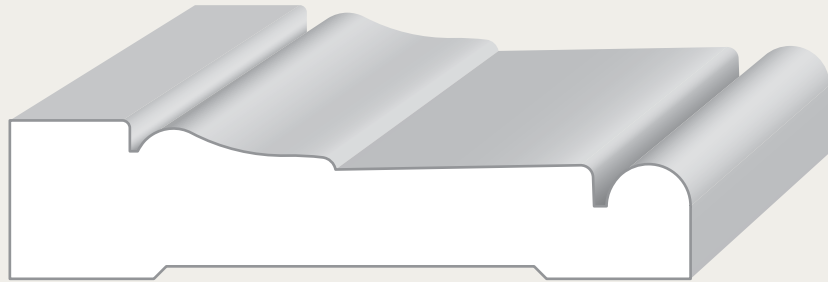

1 3/16" x 3-1/2" Moulded & Beaded Casing



SL312MB



SL312MBP

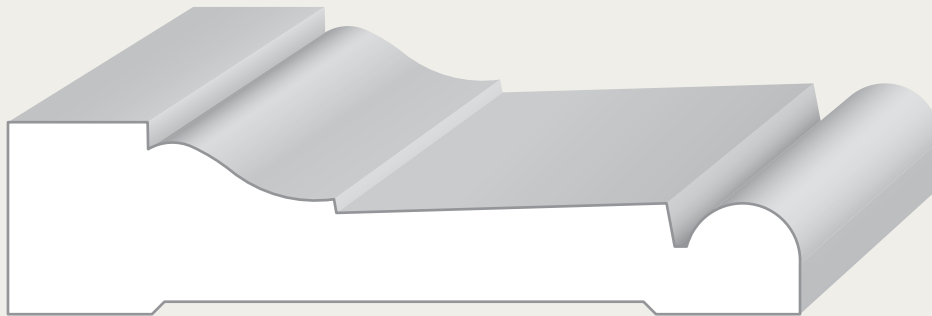

1" x 4-1/8" Beaded with Backband



SL4BWBYP



SL4BWP



ELITE TREATED[®]
AND PRIMED



YELLOW
PINE



TREATED
PINE



RED
OAK



PRIMED
FJ PINE



MDF
PRIMED



POPLAR



SAPELE



PVC



FLEX
MOULDING

CASINGS

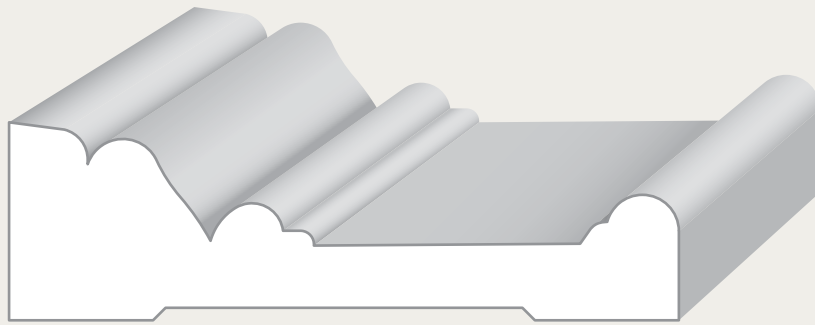

1-1/16" x 3-1/2" SL3 Casing



SL3YP



SL3P

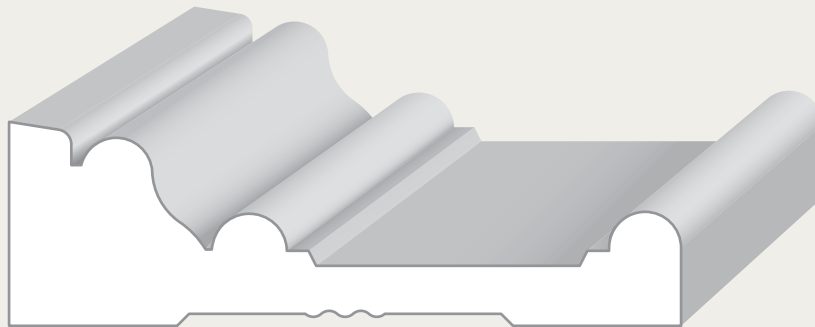

1-1/16" x 3-1/2" Finger Joint EC1 Casing – 16'



EC1



CASINGS

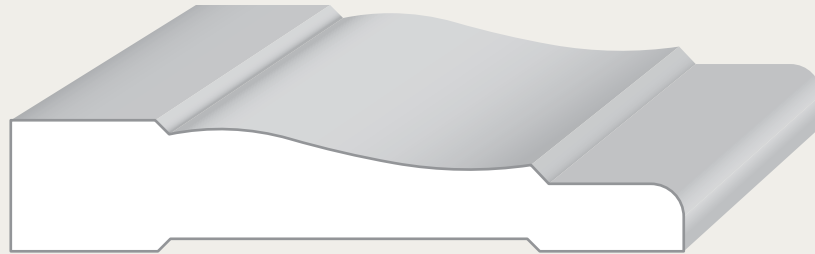

3/4" x 3-1/2" #444 Casing



11/16" x 3-1/4" Finger Joint #444 Casing - 17'



ELITE TREATED[®]
AND PRIMED



YELLOW
PINE



TREATED
PINE



RED
OAK



PRIMED
FJ PINE



MDF
PRIMED



POPLAR



SAPELE



PVC



FLEX
MOULDING

CASINGS



1 1/16" x 2-1/4" Eased Edge Casing

 **SL453YP**

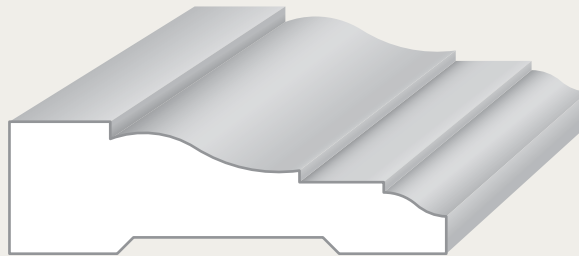

1 1/16" x 2-1/4" Moulded Casing

 **SL366YP**

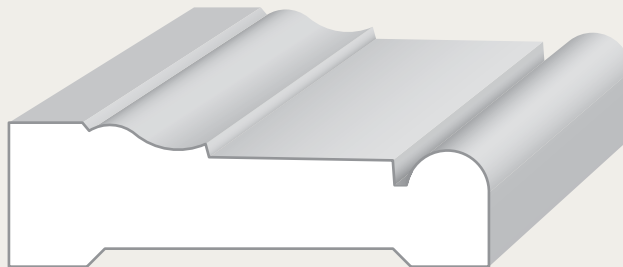

3/4" x 2-1/2" Moulded & Beaded Casing

 **SL212MBYP**



BEADED STOCK



1 x 6 Finger Joint Beaded 1 Edge

 **EC751** – net dimensions: 9/16" x 5-1/4" (primed finger joint 16')

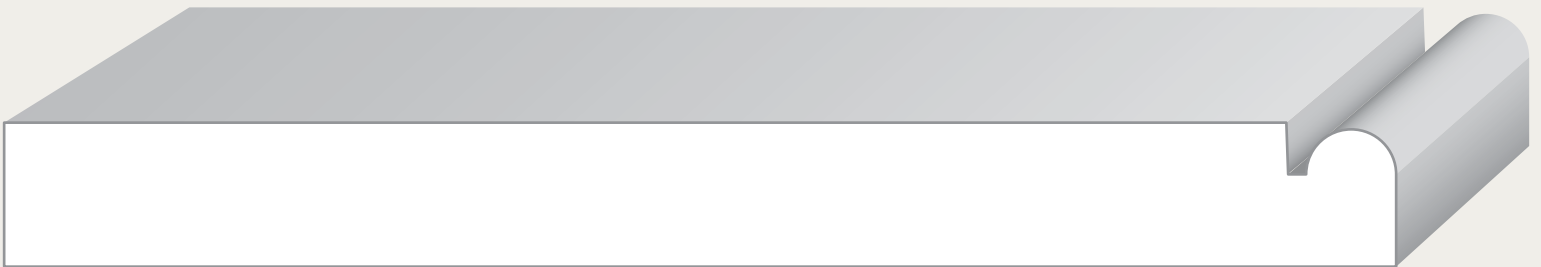

1 x 8 Beaded 1 Edge

 **SL8B1EYP**

 **SL8B1EP**



ELITE TREATED[®]
AND PRIMED



YELLOW
PINE



TREATED
PINE



RED
OAK



PRIMED
FJ PINE



MDF
PRIMED



POPLAR



SAPELE



PVC



FLEX
MOULDING

BEADED STOCK



1 x 4 Beaded 2 Edges

 **SL4B2EP**



1 x 4 Beaded 1 Edge

 **SL4B1EYP**

 **SL4B1EP**

 **SL4B1ET**



BEADED STOCK



1 x 5 Beaded 1 Edge



SL5B1EYP



SL5B1EP

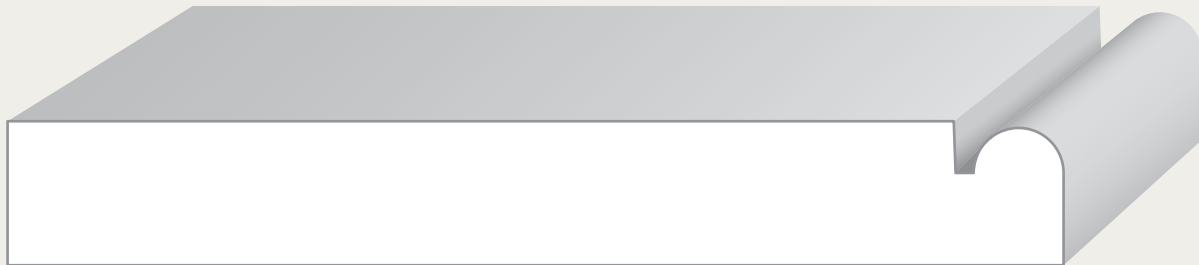

1 x 6 Beaded 1 Edge



SL6B1EYP



SL6B1EP



ELITE TREATED[®]
AND PRIMED



YELLOW
PINE



TREATED
PINE



RED
OAK



PRIMED
FJ PINE



MDF
PRIMED



POPLAR



SAPELE



PVC



FLEX
MOULDING

BACKBANDS



3/4" Radius Edge Backband
(to fit 3/4" casing)

 **SL34BB**

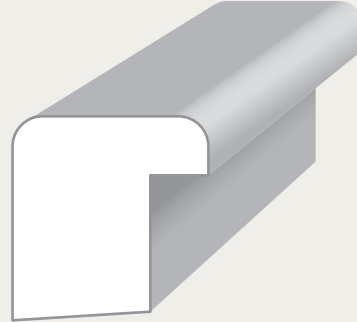

1" Radius Edge Backband
(to fit 3/4" casing)

 **SL54BB**

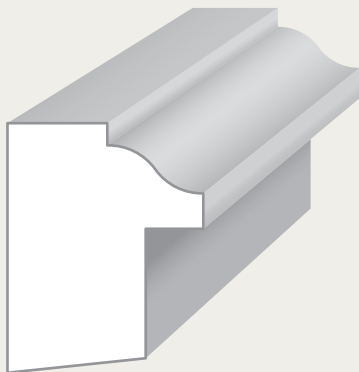

1" PG Backband
(to fit 3/4" casing)

 **SL54PGBB**

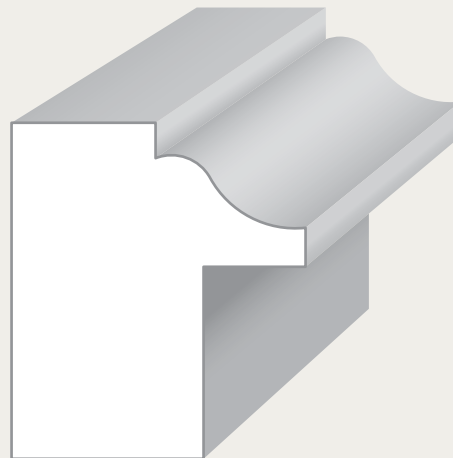

1-1/2" PG Backband
(to fit 1" casing)

 **SL112BT**



BACKBANDS

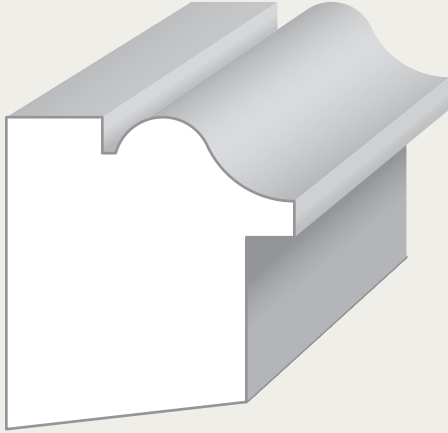

1-1/2" Moulded Backband
(to fit 1" casing)

 **SL112MBP**

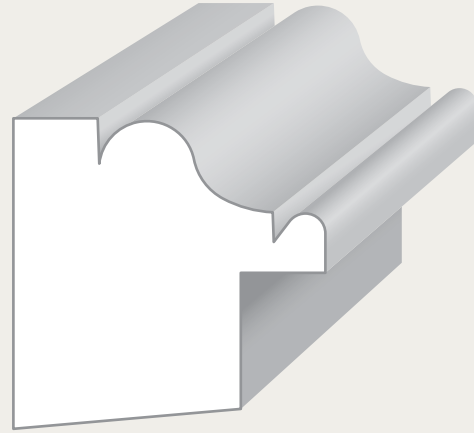

1-5/8" Beaded Backband
(to fit 3/4" casing)

 **SL158BB**

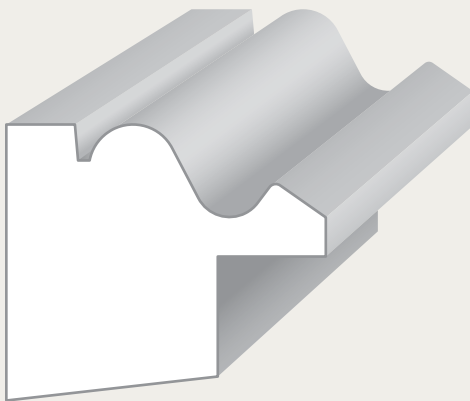

1-5/8" Heavy Backband
(to fit 3/4" casing)

 **SL158HBB**

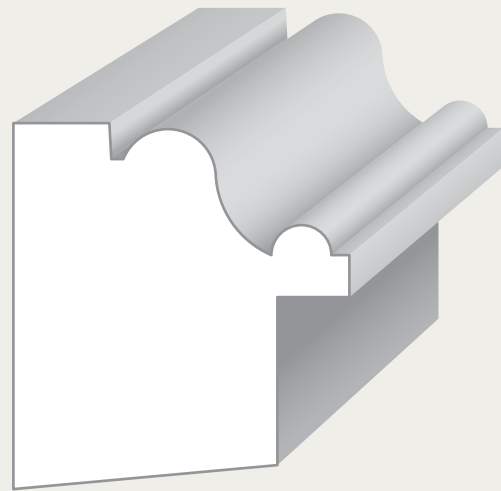

1-3/4" Benjamin Backband
(to fit 1" casing)

 **SL134BBP**



ELITE TREATED[®]
AND PRIMED



YELLOW
PINE



TREATED
PINE



RED
OAK



PRIMED
FJ PINE



MDF
PRIMED



POPLAR



SAPELE



PVC



FLEX
MOULDING

BASE MOULDINGS

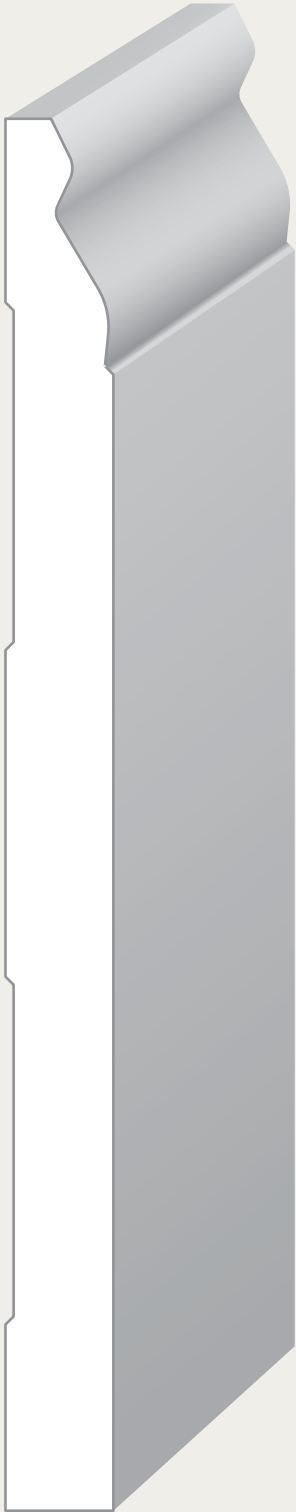

7-1/4" MDF Speed Base Moulding - 16'

 **MDF611**



7" Speed Base Moulding

 **SL810YP**
 **SL810P**



5-1/4" MDF Speed Base Moulding - 16'

 **MDF610**

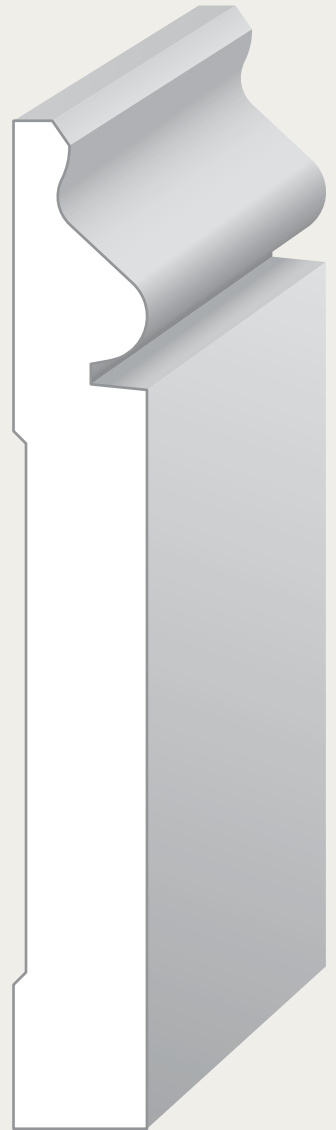

5-1/4" Speed Base Moulding

 **SL610YP**
 **SL610P**



BASE MOULDINGS



5-1/4" PG Base Moulding

 **SL618YP**



4-1/4" PG Base Moulding

 **SL620YP**



3-1/4" PG Base Moulding

 **SL623YP**



ELITE TREATED®
AND PRIMED



YELLOW
PINE



TREATED
PINE



RED
OAK



PRIMED
FJ PINE



MDF
PRIMED



POPLAR



SAPELE



PVC



FLEX
MOULDING

BASE CAP MOULDINGS

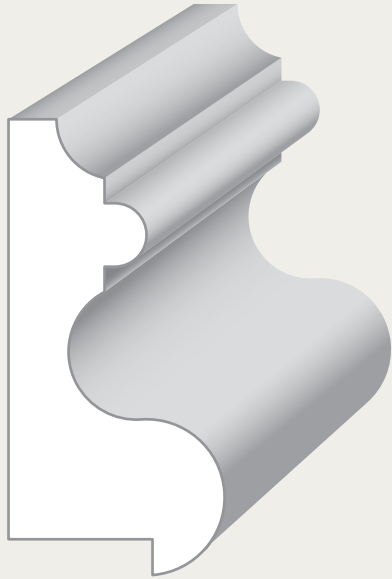

2-3/8" Base Cap Moulding for 3/4" Base

 **SL238BCP**

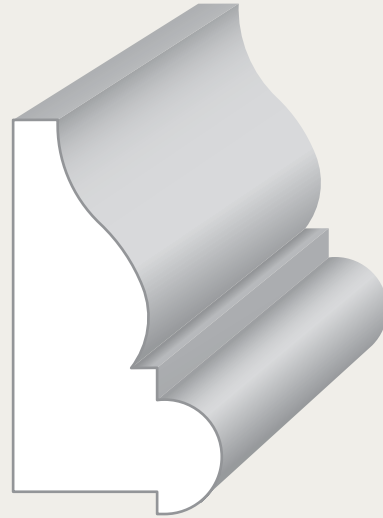

2" Base Cap Moulding for 3/4" Base

 **SL2BCP**

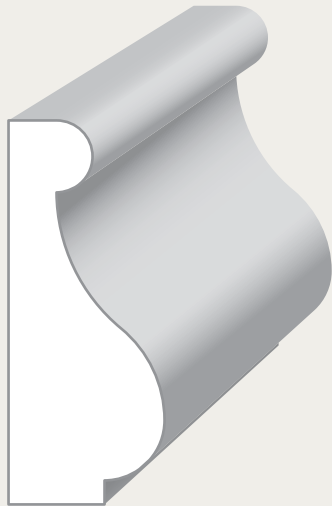

2" Base Cap Moulding with Bead Top

 **SL2BCWBP**

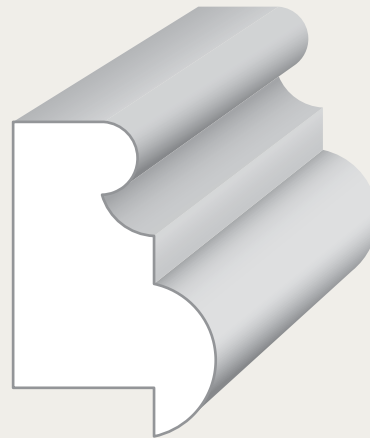

1-5/8" Base Cap Moulding for 3/4" Base

 **SL203P**



BASE CAP MOULDINGS

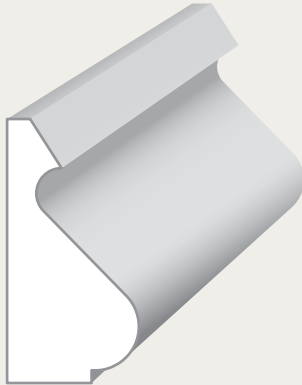

1-3/8" Base Cap Moulding

 **SL163T**

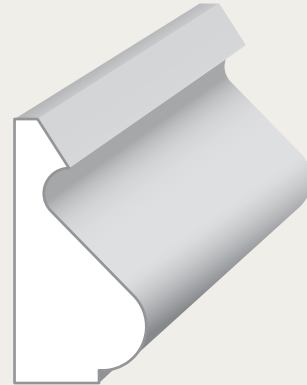

1-3/8" Base Cap Moulding - 16'

 **MDF163**

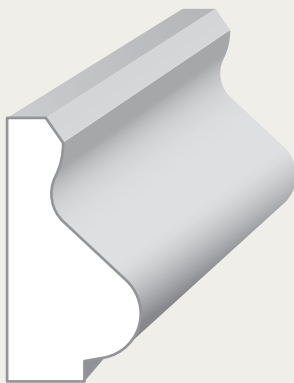

1-3/8" Speed Base Cap Moulding

 **SLSBCP**

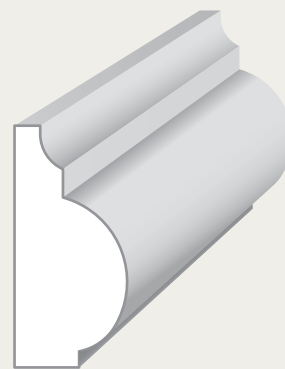

1-1/4" Base Cap Moulding with Cove

 **SL1201P**



ELITE TREATED[®]
AND PRIMED



YELLOW
PINE



TREATED
PINE



RED
OAK



PRIMED
FJ PINE



MDF
PRIMED



POPLAR



SAPELE



PVC



FLEX
MOULDING

BASE CAP MOULDINGS

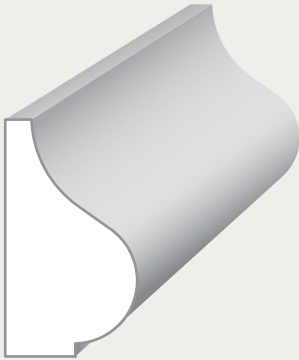

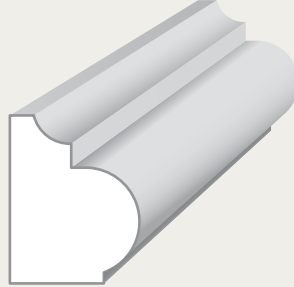

1-1/4" Base Cap Moulding No Cove

 **SL166P**



7/8" Base Cap Moulding with Cove

 **SL1207P**

 **SL1207T**

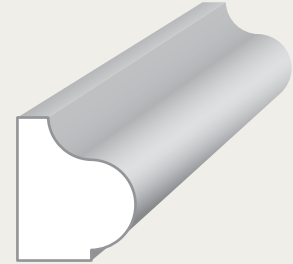

3/4" Base Cap Moulding No Cove

 **SL172P**

SHOE MOULDING

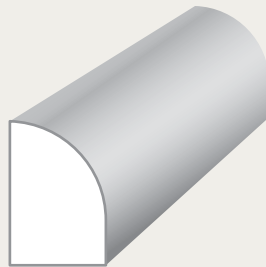

1/2" x 3/4" Shoe Moulding

 **SLSO**

 **SLSYP**

 **SLSYPP**

 **SLSF - 12'**



PANEL MOULDINGS

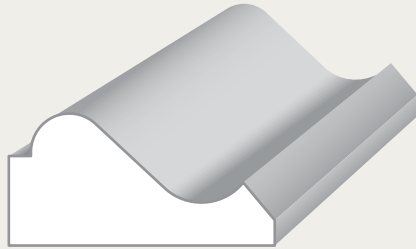

1-3/8" Panel Moulding

SL138PM

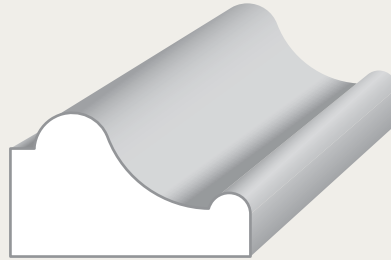

1-1/4" Beaded Panel Moulding

SL114PM

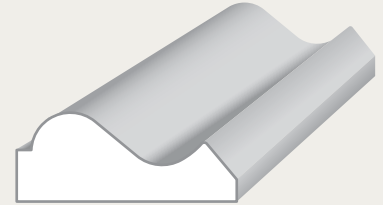

1-1/8" Panel Moulding

SL118PM

CABINET MOULDING

PICTURE MOULDING

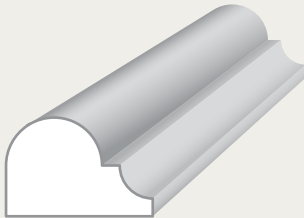

3/4" Small Cabinet Moulding

SLSCM

SLSCMT

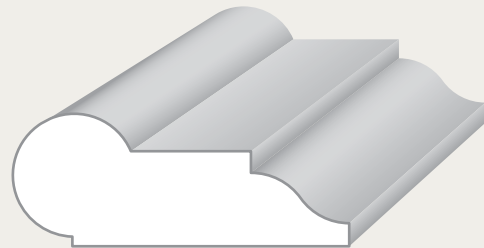

1-3/4" Picture Moulding

SL273P



ELITE TREATED[®]
AND PRIMED



YELLOW
PINE



TREATED
PINE



RED
OAK



PRIMED
FJ PINE



MDF
PRIMED



POPLAR



SAPELE



PVC



FLEX
MOULDING

CORNER MOULDING

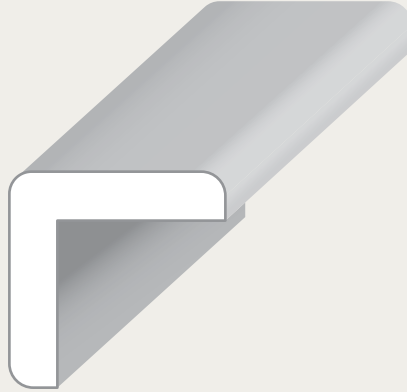

1-1/8" Large Outside Corner

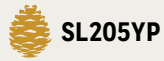

SL205YP

BEAUTI MOULDINGS

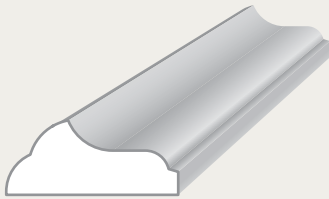

3/8" x 7/8" Beauti Moulding



M40P

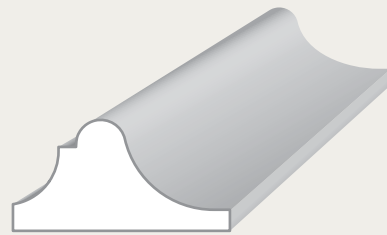

9/16" x 1-1/8" Beauti Moulding



M130P



CHAIR RAILS

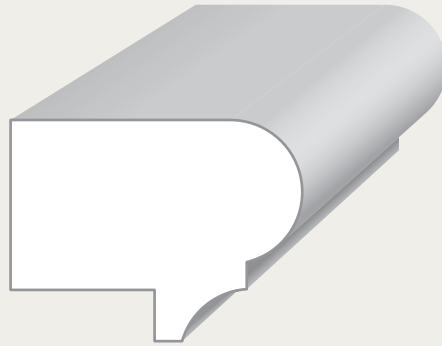

1-1/2" Chair Rail Cap

 **SL288P**

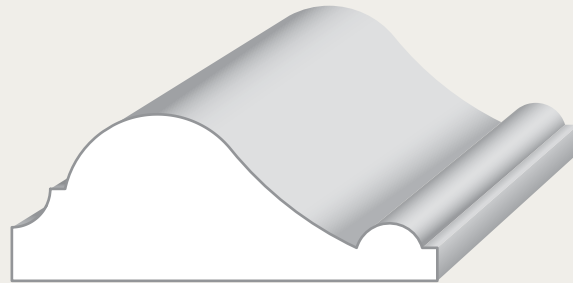

2-1/4" Small Williamsburg

 **SLSWCR**



ELITE TREATED[®]
AND PRIMED



YELLOW
PINE



TREATED
PINE



RED
OAK



PRIMED
FJ PINE



MDF
PRIMED



POPLAR



SAPELE



PVC



FLEX
MOULDING

STOPS

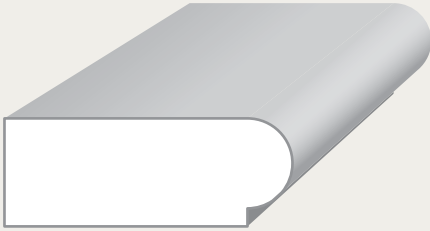

9/16" x 1-1/2" Treated Beaded Stop

 **SLYPBSTL**



7/16" x 1-5/8" Eased Edge Stop

 **SL875YP**

 **SL875P**

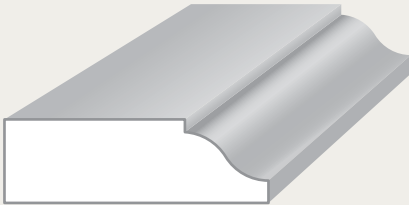

7/16" x 1-3/8" PG Stop

 **SL936YP**

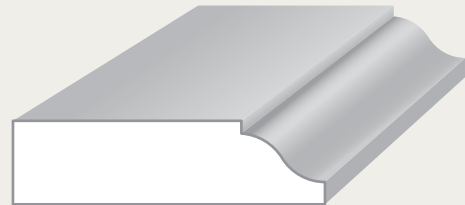

7/16" x 1-5/8" PG Stop

 **SL935YP**



STOPS

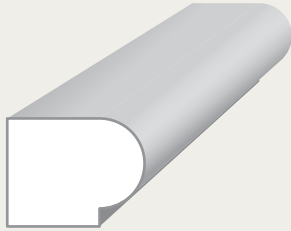

9/16" x 11/16" Beaded Stop



SLYPBS



SLPBS

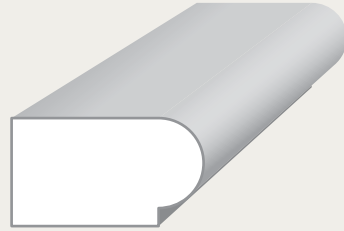

9/16" x 1" Treated Beaded Stop



SLYPBST



9/16" x 3-1/4" Double Beaded Stop



SL4DB

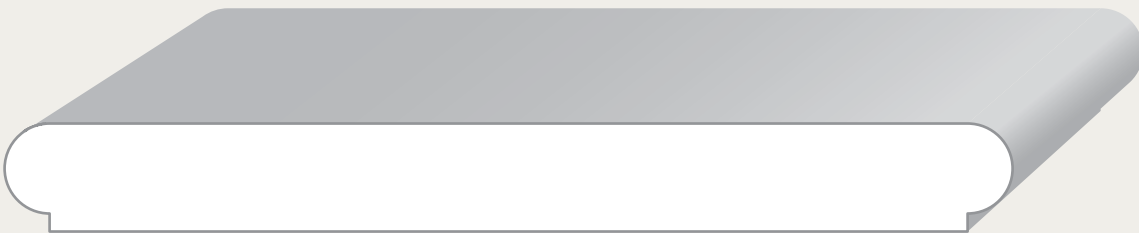

9/16" x 5-1/4" Double Beaded Stop

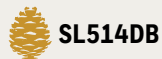

SL514DB



ELITE TREATED[®]
AND PRIMED



YELLOW
PINE



TREATED
PINE



RED
OAK



PRIMED
FJ PINE



MDF
PRIMED



POPLAR



SAPELE



PVC



FLEX
MOULDING

QUARTER ROUND MOULDINGS

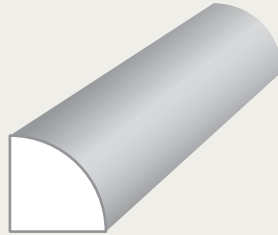

1/2" Quarter Round

 **SL108YP**

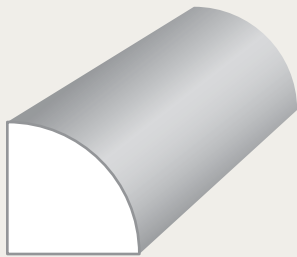

3/4" Quarter Round

 **SL106YP**

 **SL106T**

 **SL106O**

 **SL106P**

 **SL106F - 12'**

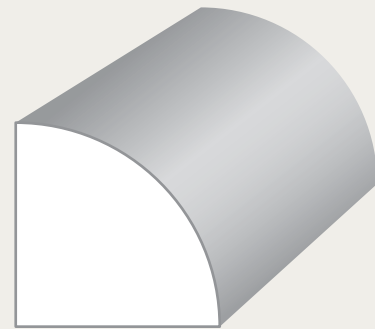

1" Quarter Round

 **SL103YP**

 **SL103T**



FULL ROUND MOULDING

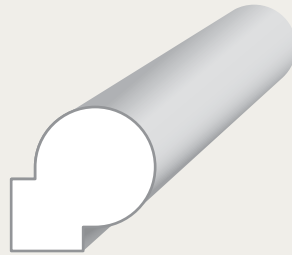

3/4" Full Round for Corners

 **SL34FRP**

 **SL34FRT**

HALF ROUND MOULDINGS

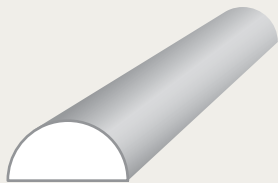

5/8" Half Round

 **SL123YP**

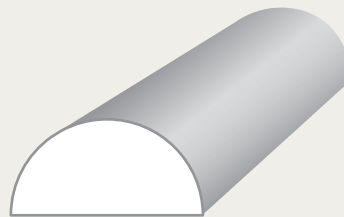

1" Net Half Round

 **SL120T**



ELITE TREATED[®]
AND PRIMED



YELLOW
PINE



TREATED
PINE



RED
OAK



PRIMED
FJ PINE



MDF
PRIMED



POPLAR



SAPELE



PVC



FLEX
MOULDING

NOSINGS

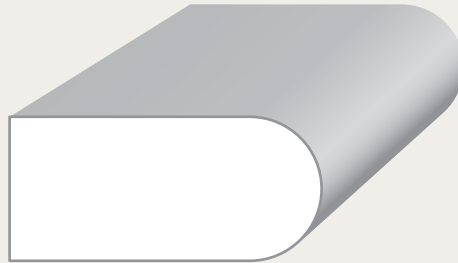

3/4" x 1-5/8" Nosing

 **SL34NP**



1" x 2-1/2" Nosing

 **SL54212NP**



MULLION

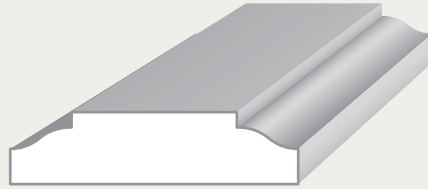

3/8" x 1-1/2" PG Mullion

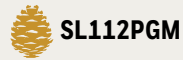

STOOLS



1" x 3-1/4" Window Stool



ELITE TREATED[®]
AND PRIMED



YELLOW
PINE



TREATED
PINE



RED
OAK



PRIMED
FJ PINE



MDF
PRIMED



POPLAR



SAPELE



PVC



FLEX
MOULDING

STOOLS



11/16" x 5-1/4" Finger Joint Window Stool - 16'

 **EC10215**



1" x 2-1/2" Window Stool

 **SLWS212P**



STOOLS



1" x 6" Window Stool

 **SL54WS6P**

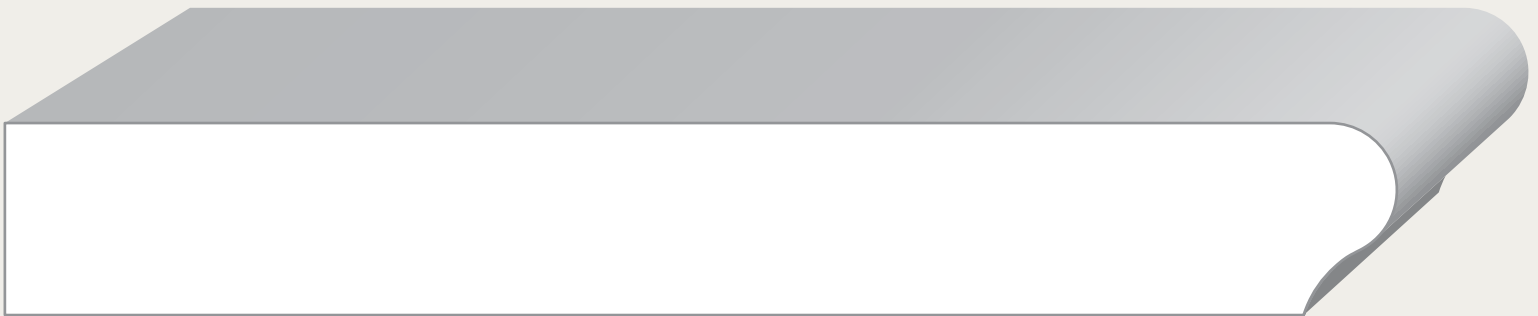

1" x 8" Window Stool

 **SL54WS8P**



ELITE TREATED[®]
AND PRIMED



YELLOW
PINE



TREATED
PINE



RED
OAK



PRIMED
FJ PINE



MDF
PRIMED



POPLAR



SAPELE



PVC



FLEX
MOULDING

CHAMFER STRIP

SCREEN MOULDING

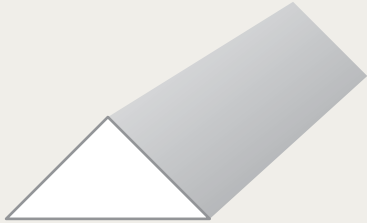

3/4" Chamfer Strip

SLCSB – *Banak Species*

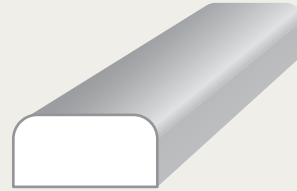

3/4" Heavy Screen Mould

 **SLSSM**

LATTICE



5/16" x 1-1/2" Lattice

 **SL266YP**

 **SL266T**



SHINGLE MOULDINGS

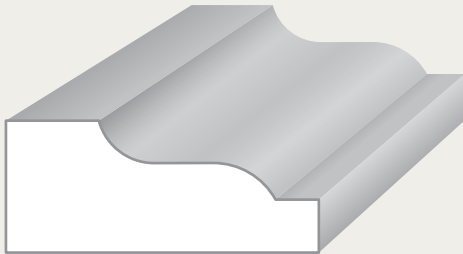

1-5/8" Shingle Moulding



2-1/2" Shingle Moulding #207



BACK MOULDINGS

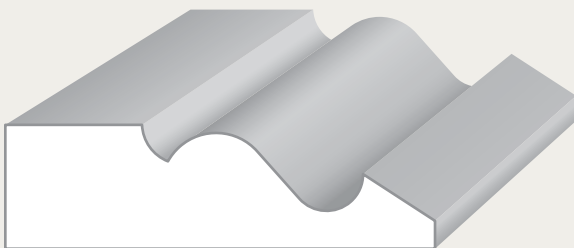

2-1/4" Back Moulding

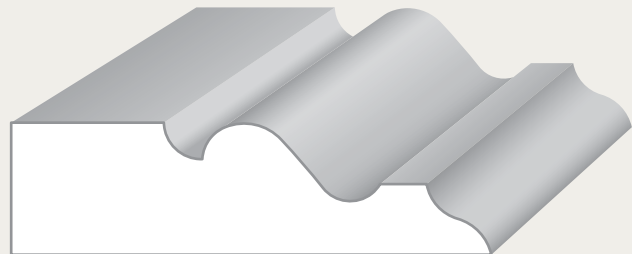

2-1/2" Back Moulding



ELITE TREATED®
AND PRIMED



YELLOW
PINE



TREATED
PINE



RED
OAK



PRIMED
FJ PINE



MDF
PRIMED



POPLAR



SAPELE



PVC



FLEX
MOULDING

DRIP CAPS

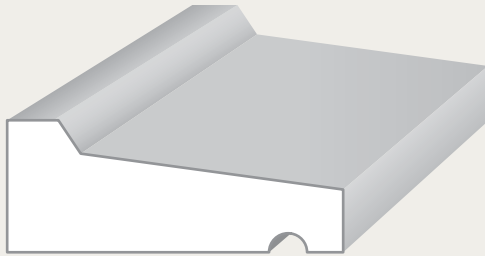

11/16" x 1-3/4" Drip Cap



SL196T

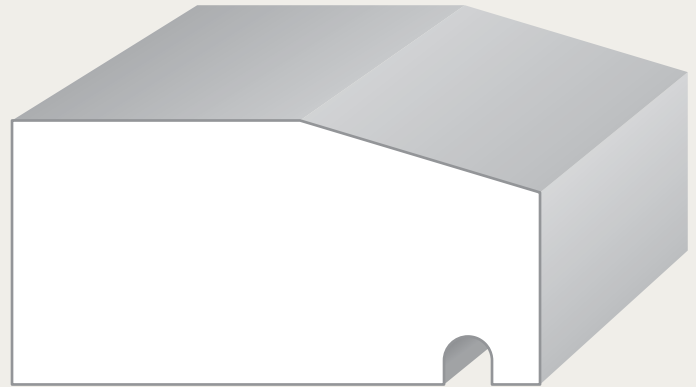

1-3/8" x 2-3/4" Drip Cap*



SLLDC

**Prefabricated Copper Flashing Available*

WINDOW CAP

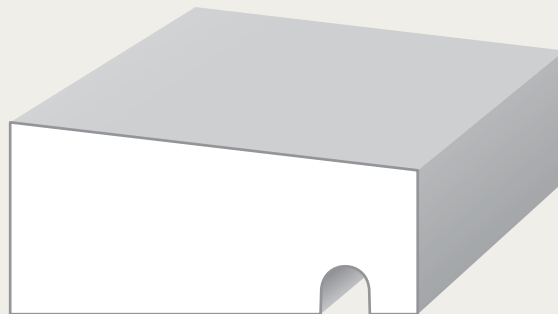

1" x 2-1/8" Window Cap*



SLTWC

**Prefabricated Copper Flashing Available*



SILL NOSING

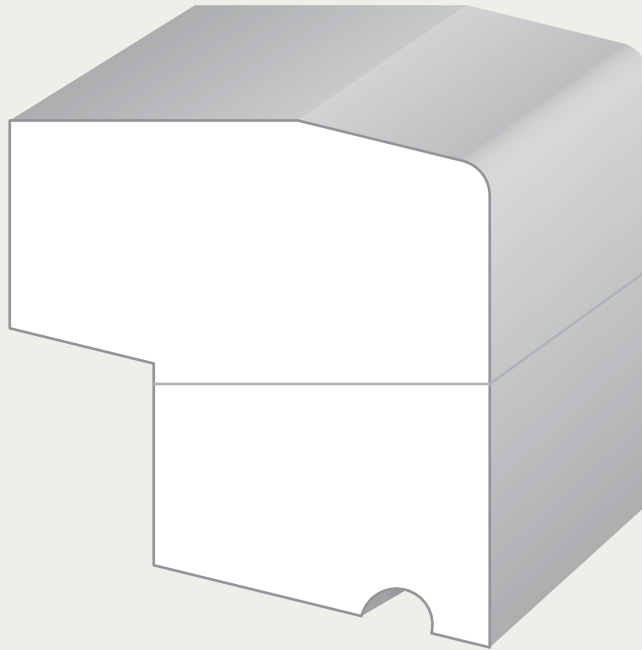

2-1/2" x 2-3/4" Sill Nosing For Clad Windows



CWSNT – Laminated Elite Treated® and Primed

BRICK MOULDINGS

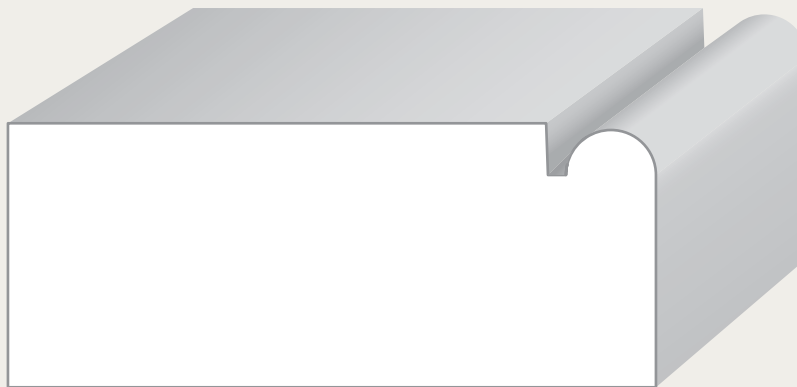

1-3/8" x 3-3/8" Beaded Brick Moulding



SL338BMT



ELITE TREATED®
AND PRIMED



YELLOW
PINE



TREATED
PINE



RED
OAK



PRIMED
FJ PINE



MDF
PRIMED



POPLAR



SAPELE



PVC



FLEX
MOULDING

BRICK MOULDINGS

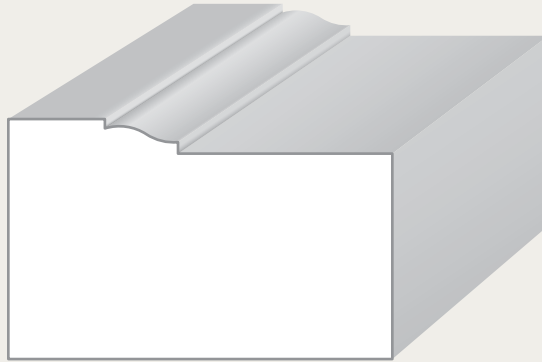

1-1/4" x 2" Brick Moulding



SL180T8 – *Elite Treated® and Primed 8'*



SL180T10 – *Elite Treated® and Primed 10'*



SL180T12 – *Elite Treated® and Primed 12'*

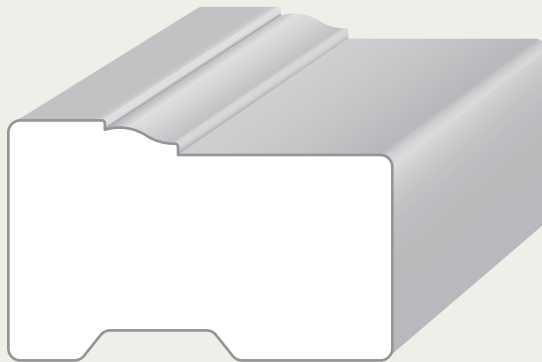

1-1/4" x 2" Brick Moulding



PVCBM – *PVC Brick Moulding 17'*



COLUMN BASE MOULDING

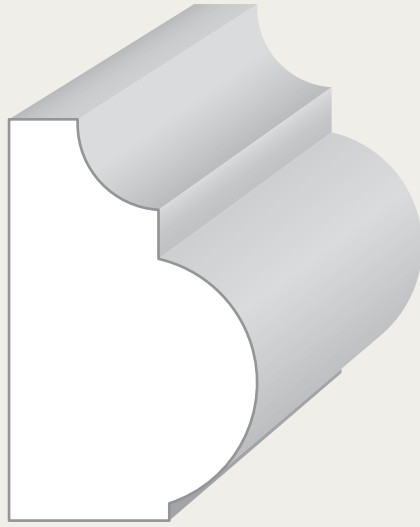

2" Column Base Moulding with Cove



SL2CBM

SIDINGS

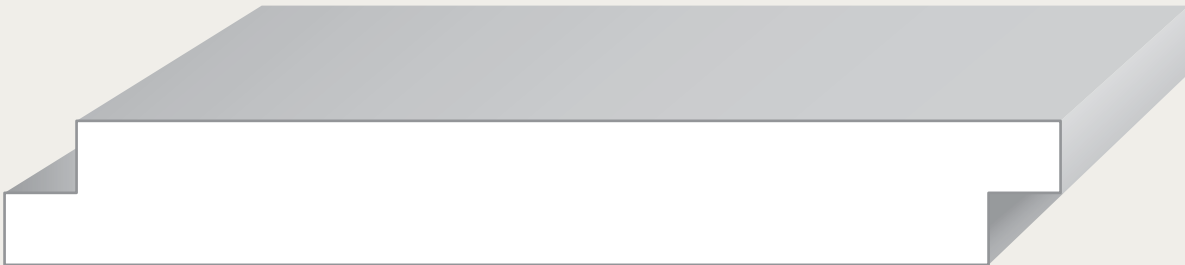

1 x 6 Shiplap Siding (No Reveal)



6LAPCTP8 - Elite Treated® and Primed 8'



6LAPCTP10 - Elite Treated® and Primed 10'



6LAPCTP12 - Elite Treated® and Primed 12'



6LAPCTP14 - Elite Treated® and Primed 14'



6LAPCTP16 - Elite Treated® and Primed 16'



ELITE TREATED®
AND PRIMED



YELLOW
PINE



TREATED
PINE



RED
OAK



PRIMED
FJ PINE



MDF
PRIMED



POPLAR



SAPELE



PVC



FLEX
MOULDING

SIDINGS



1 x 6 Novelty Siding Pattern #105



6105CTP8 – Elite Treated® and Primed 8'



6105CTP10 – Elite Treated® and Primed 10'



6105CTP12 – Elite Treated® and Primed 12'



6105CTP14 – Elite Treated® and Primed 14'



6105CTP16 – Elite Treated® and Primed 16'



1 x 8 Novelty Siding Pattern #105



8105CTP8 – Elite Treated® and Primed 8'



8105CTP10 – Elite Treated® and Primed 10'



8105CTP12 – Elite Treated® and Primed 12'



8105CTP14 – Elite Treated® and Primed 14'



8105CTP16 – Elite Treated® and Primed 16'



SIDINGS



1 x 8 Beaded Siding Pattern #145



8145CTP8 – Elite Treated® and Primed 8'



8145CTP10 – Elite Treated® and Primed 10'



8145CTP12 – Elite Treated® and Primed 12'



8145CTP14 – Elite Treated® and Primed 14'



8145CTP16 – Elite Treated® and Primed 16'

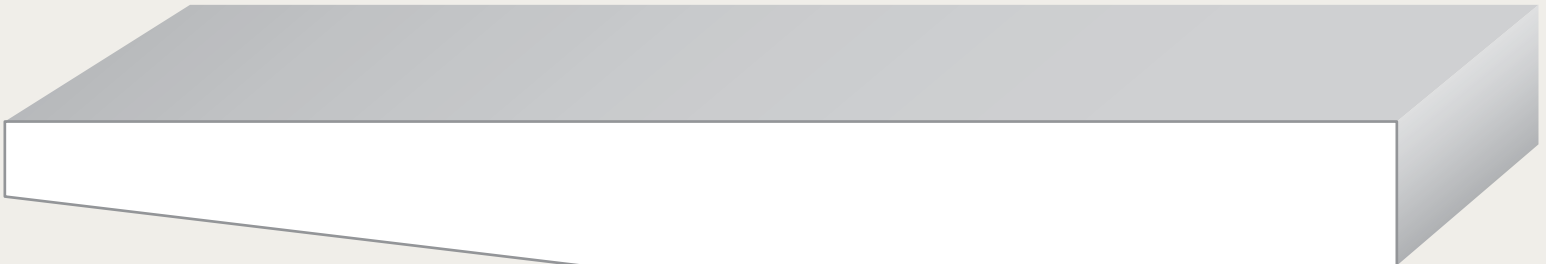

1 x 8 Beveled Siding Pattern #143



8143CTP8 – Elite Treated® and Primed 8'



8143CTP10 – Elite Treated® and Primed 10'



8143CTP12 – Elite Treated® and Primed 12'



8143CTP14 – Elite Treated® and Primed 14'



8143CTP16 – Elite Treated® and Primed 16'



ELITE TREATED®
AND PRIMED



YELLOW
PINE



TREATED
PINE



RED
OAK



PRIMED
FJ PINE



MDF
PRIMED



POPLAR



SAPELE



PVC



FLEX
MOULDING

SIDINGS

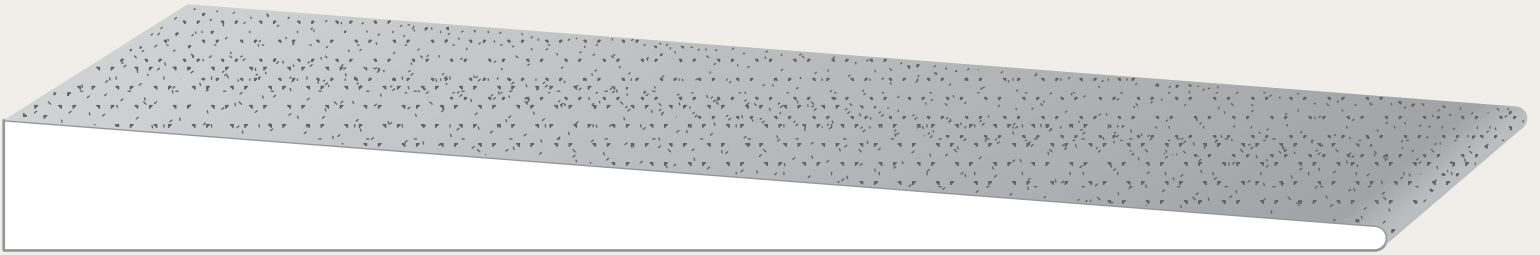

1 1/16" x 7-1/4" Bevel Siding (Rough Face)

- 🔥 **8WRCB** – Kiln Dried Select Tight Knot Cedar
- 🔥 **8WRCBP** – Kiln Dried Select Tight Knot Cedar and Primed

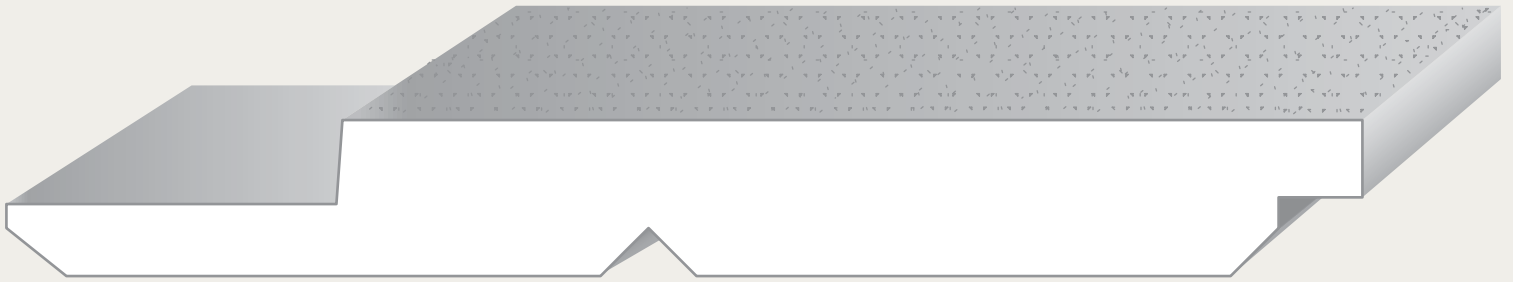

1 x 8 Channel Rustic Siding (Rough Face)

- 🔥 **18CRC** – Kiln Dried Select Tight Knot Cedar

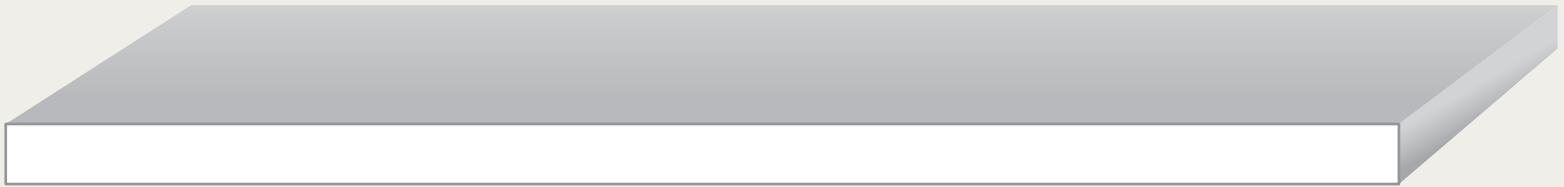

5/16" x 7-1/4" Smooth Fiber Cement Siding

- 🌿 **7HSL12** – HardiePlank® HZ10 Smooth Lap Siding 12'
- 🌿 **7SL12** – Allura™ Smooth Lap Siding 12'
- 🌿 **8SL12** – Allura™ Smooth Lap Siding 5/16" x 8-1/4" x 12' (not shown)



SIDINGS

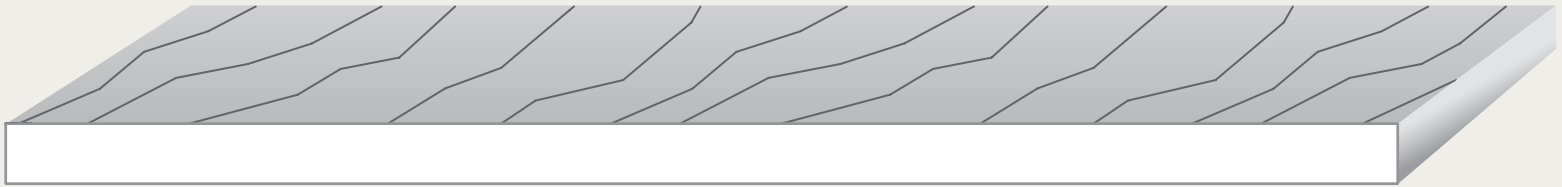

5/16" x 7-1/4" Woodgrain Fiber Cement Siding

 **7HWL12** – HardiePlank® HZ10 CEDARMILL Lap Siding 12'

 **7WL12** – Allura™ CEDAR Lap Siding 12'

The following fiber cement siding products also available in stock:

 **HS48** – Allura™ Smooth 5/16" x 4' x 8'

 **HS410** – Allura™ Smooth 5/16" x 4' x 10'

The following fiber cement soffit products also available in stock:

 **12SHS** – Allura™ 1/4" x 12" x 12' Smooth Non-Vented

 **12VHS** – Allura™ 1/4" x 12" x 12' Smooth Vented

 **16SHS** – Allura™ 1/4" x 12" x 12' Smooth Non-Vented

 **16VHS** – Allura™ 1/4" x 12" x 12' Smooth Vented

 **24SHS** – Allura™ 1/4" x 24" x 12' Smooth Non-Vented



ELITE TREATED[®]
AND PRIMED



YELLOW
PINE



TREATED
PINE



HARDIEPLANK



ALLURA



WESTERN
RED CEDAR



POPLAR



SAPELE



IPE

SIDINGS

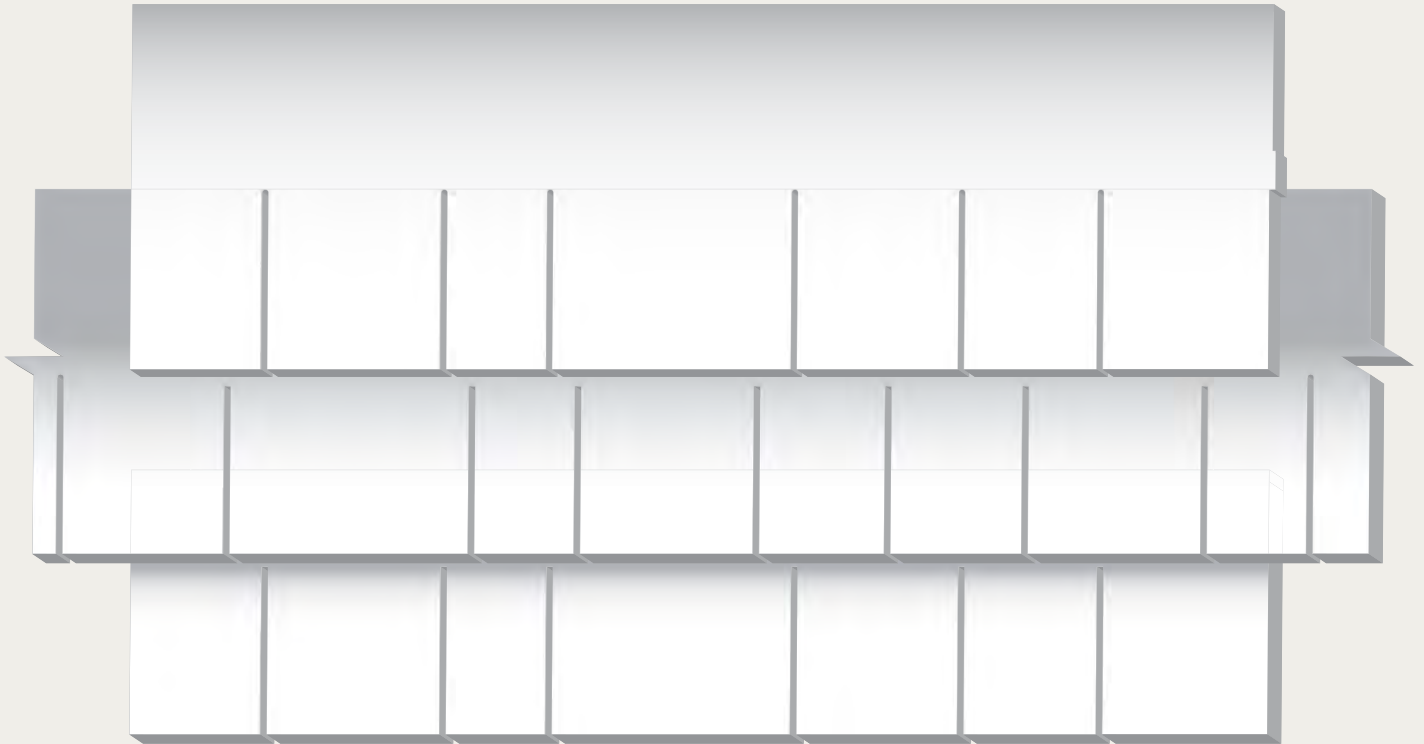

1/4" x 16" x 48" Straight Edge Panel

 **ASHGPNL** – Allura™ Straight Edge Panel
(Sold per piece - Approximately 43 pcs per square based on 7" reveal)





*Drawing shown at 1/8 scale



CEILINGING & WALLS



1 x 4 T&G Beaded Ceiling (Reversible Small V)

-  **4BVCYP8** – C&Btr. Yellow Pine 8'
-  **4BVCYP10** – C&Btr. Yellow Pine 10'
-  **4BVCYP12** – C&Btr. Yellow Pine 12'
-  **4BVCYP14** – C&Btr. Yellow Pine 14'
-  **4BVCYP16** – C&Btr. Yellow Pine 16'

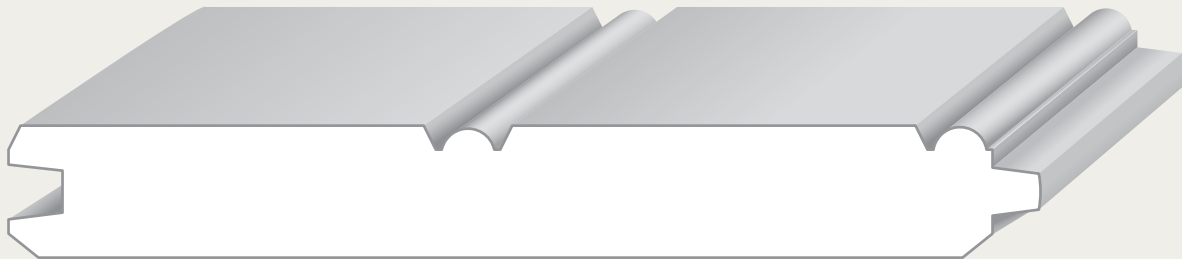

1 x 6 T&G Beaded Ceiling (Reversible Small V)

-  **6BC8** – C&Btr. Yellow Pine 8'
-  **6BC10** – C&Btr. Yellow Pine 10'
-  **6BC12** – C&Btr. Yellow Pine 12'
-  **6BC14** – C&Btr. Yellow Pine 14'
-  **6BC16** – C&Btr. Yellow Pine 16'



CEILINGING & WALLS

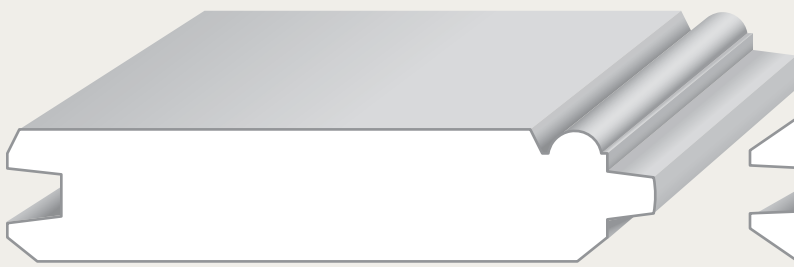



1 x 4 T&G Beaded 1 Edge Ceiling (Small V)

 **4TGB1E** – Primed C&Btr. Yellow Pine





1 x 4 T&G V-Edge (Large V)

 **4TGVYP8** – Primed C&Btr. Yellow Pine 8'

 **4TGVYP10** – Primed C&Btr. Yellow Pine 10'

 **4TGVYP12** – Primed C&Btr. Yellow Pine 12'

 **4TGVYP14** – Primed C&Btr. Yellow Pine 14'

 **4TGVYP16** – Primed C&Btr. Yellow Pine 16'

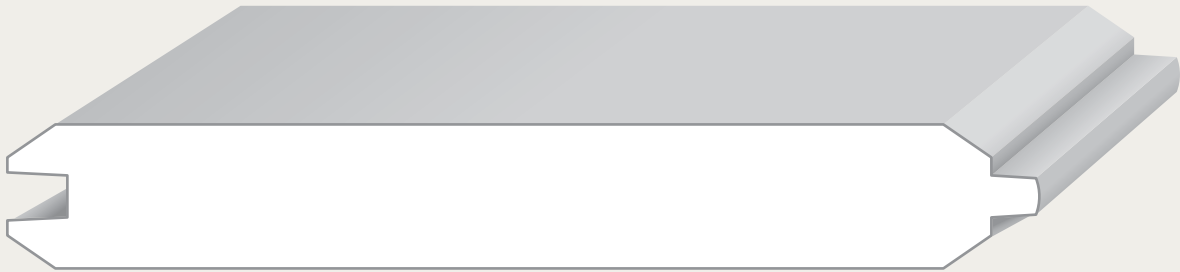

1 x 6 T&G V-Edge (Large V)

 **16TGV**

 **6TGVYP8** – Primed C&Btr. Yellow Pine 8'

 **6TGVYP10** – Primed C&Btr. Yellow Pine 10'

 **6TGVYP12** – Primed C&Btr. Yellow Pine 12'

 **6TGVYP14** – Primed C&Btr. Yellow Pine 14'





 **6TGVYP16** – Primed C&Btr. Yellow Pine 16'

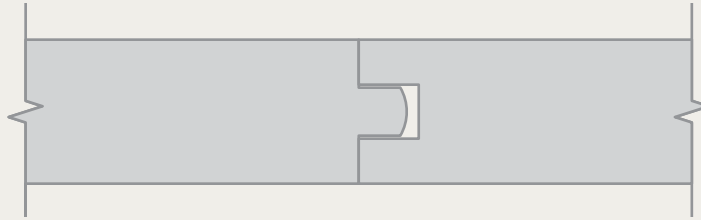

CEILINGING & WALLS







1 x 6 T&G Center Match

-  **6TGCMP8** – Poplar 8'
-  **6TGCMP10** – Poplar 10'
-  **6TGCMP12** – Poplar 12'
-  **6TGCMP14** – Poplar 14'
-  **6TGCMP16** – Poplar 16'



1 x 8 T&G Center Match

-  **8TGCMP8** – Poplar 8'
-  **8TGCMP10** – Poplar 10'
-  **8TGCMP12** – Poplar 12'
-  **8TGCMP14** – Poplar 14'
-  **8TGCMP16** – Poplar 16'



ELITE TREATED®
AND PRIMED



YELLOW
PINE



TREATED
PINE



HARDIEPLANK



ALLURA



WESTERN
RED CEDAR



POPLAR



SAPELE



IPE

CEILINGING & WALLS

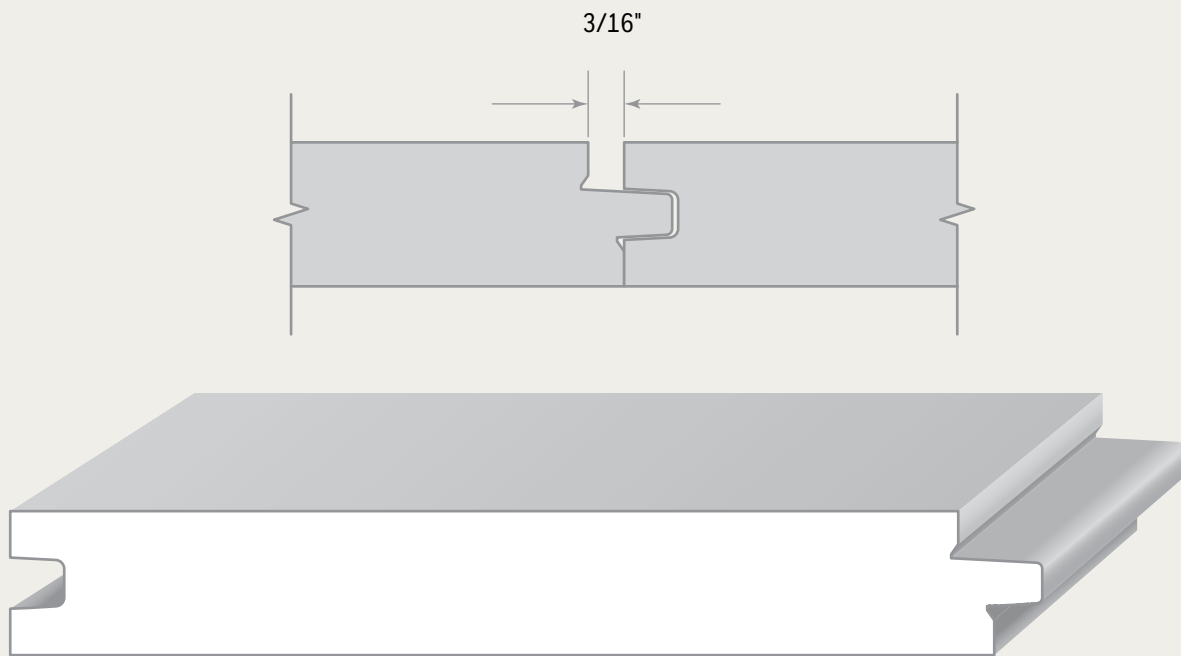

1 x 6 T&G with 3/16" Reveal



6TGWRYP8 - C&Btr. Yellow Pine 8'



6TGWRYP10 - C&Btr. Yellow Pine 10'



6TGWRYP12 - C&Btr. Yellow Pine 12'



6TGWRYP14 - C&Btr. Yellow Pine 14'



6TGWRYP16 - C&Btr. Yellow Pine 16'



6TGWRP8 - Poplar 8'



6TGWRP10 - Poplar 10'



6TGWRP12 - Poplar 12'



6TGWRP14 - Poplar 14'



6TGWRP16 - Poplar 16'



CEILINGING & WALLS

3/16"

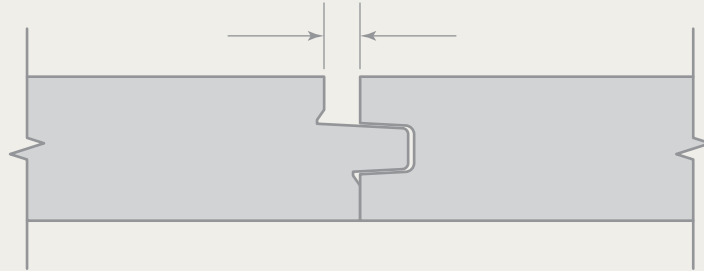

1 x 8 T&G with 3/16" Reveal



8TGWRYP8 - C&Btr. Yellow Pine 8'



8TGWRYP10 - C&Btr. Yellow Pine 10'



8TGWRYP12 - C&Btr. Yellow Pine 12'



8TGWRYP14 - C&Btr. Yellow Pine 14'



8TGWRYP16 - C&Btr. Yellow Pine 16'



8TGWRP8 - Poplar 8'



8TGWRP10 - Poplar 10'



8TGWRP12 - Poplar 12'



8TGWRP14 - Poplar 14'



8TGWRP16 - Poplar 16'



ELITE TREATED[®]
AND PRIMED



YELLOW
PINE



TREATED
PINE



HARDIEPLANK



ALLURA



WESTERN
RED CEDAR



POPLAR



SAPELE



IPE

STAIR TREADS



1" x 11-1/4" net Nosed 1 Edge



***5412NCYP** - C&Btr. Yellow Pine



1" x 11-1/4" Nosed Tread



****360T** - 11-1/4" Oak Treads 36"



****420T** - 11-1/4" Oak Treads 42" (shown)



****480T** - 11-1/4" Oak Treads 48"



1" x 11-1/4" Returned Nosed Tread



****420RT** - Returned Oak Treads 42" (shown)



****480RT** - Returned Oak Treads 48"



****540RT** - Returned Oak Treads 54"

*Drawing shown at 1/2 scale

**Drawing shown at 1/8 scale



STAIR NOSING

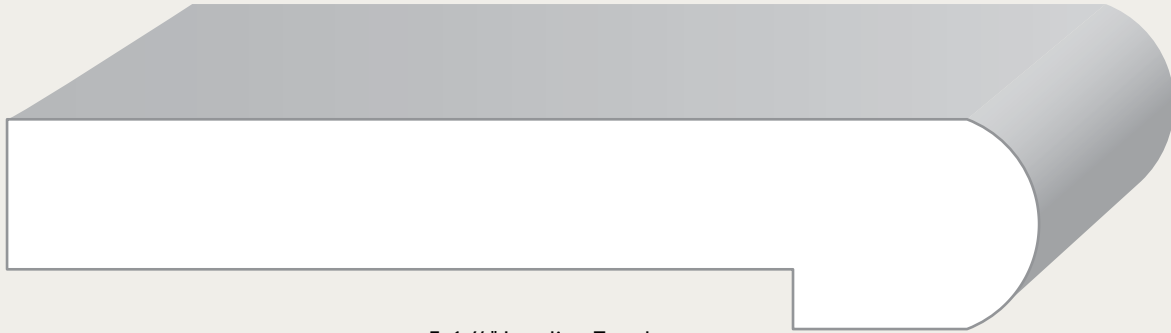

5-1/4" Landing Tread

 **80905**

STAIR RAILS

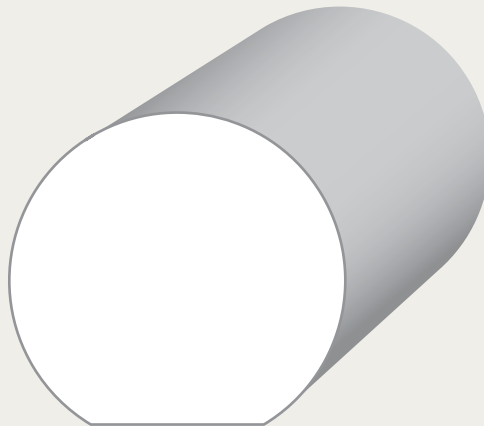

1-3/4" x 1-5/8" Profile 6040 Stair Rail

 **6040**



ELITE TREATED[®]
AND PRIMED



YELLOW
PINE



TREATED
PINE



RED
OAK



PRIMED
FJ PINE



MDF
PRIMED



POPLAR



SAPELE



PVC





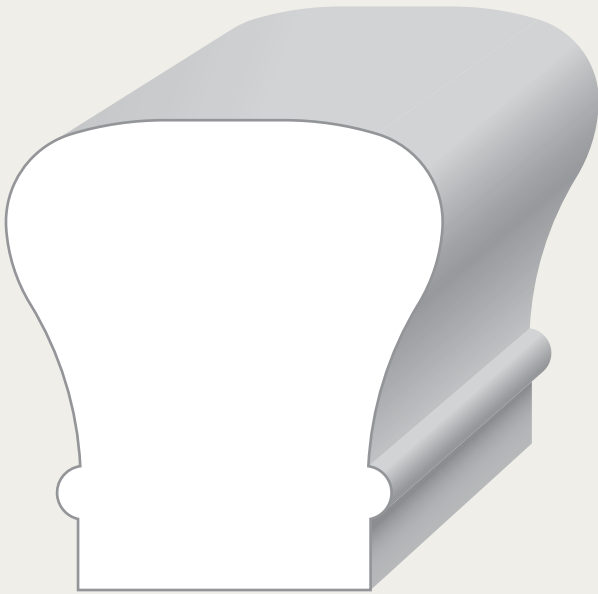

FLEX
MOULDING

STAIR RAILS



2-1/4" x 2-7/16" Profile 6010 Stair Rail

-  **6010** - Red Oak
-  **7011** - Red Oak Level Quarter Turn
-  **7012** - Red Oak 60° Upeasing
-  **7013** - Red Oak 60° Overeasing

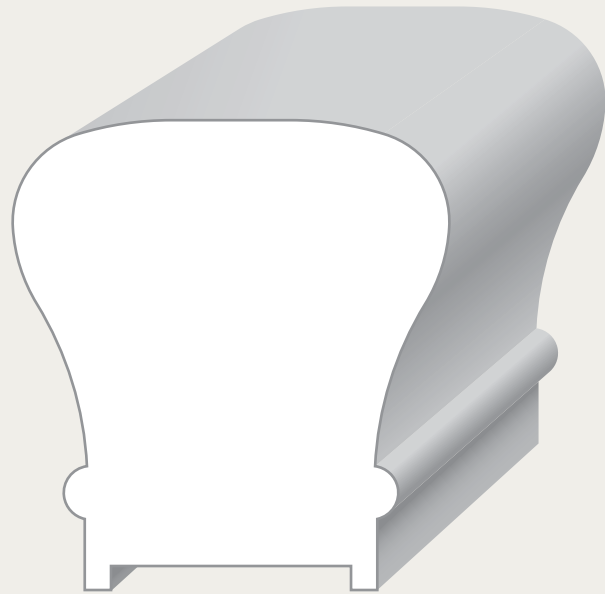

2-1/4" x 2-7/16" Profile 6010 Stair Rail with 1-1/4" Plow & Fillet

-  **6010P8** - Red Oak 8'
-  **6010P10** - Red Oak 10'
-  **6010P12** - Red Oak 12'
-  **6010P16** - Red Oak 16'
-  **7011** - Red Oak Level Quarter Turn (no plow)
-  **7012** - Red Oak 60° Upeasing (no plow)
-  **7013** - Red Oak 60° Overeasing (no plow)

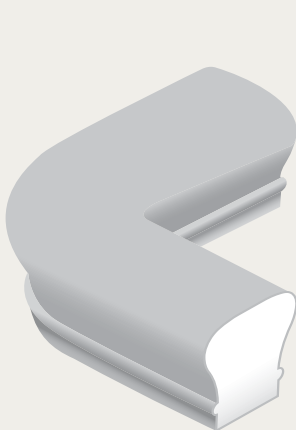

7011



7012



7013



STAIR RAILS



3-1/2" x 3-1/2" Laminated

312LAMP - Poplar 5'

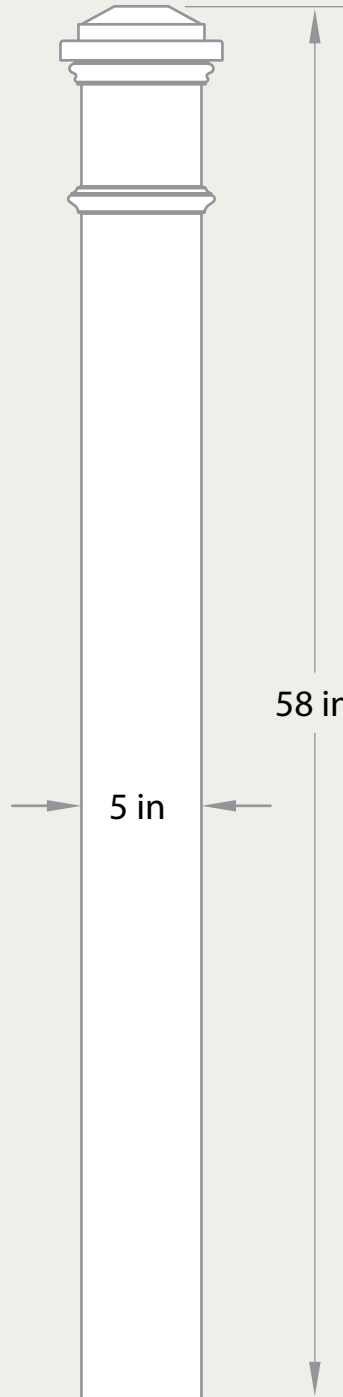

5" x 5" Primed Newel

4095P - Primed 58"



5060 Balusters 1-1/4"

506042P - Primed 42"



ELITE TREATED® AND PRIMED



YELLOW PINE



TREATED PINE



KDAT



FIBERBOARD



FIBER CEMENT



WESTERN RED CEDAR



TRU EXTERIOR



PRIMED



PVC

EXPERIENCE THE *Southern* DIFFERENCE

FLOORING



1 x 4 T&G Flooring

 **14PF2** – #2 Yellow Pine

 **14PFC** – C&Btr. Yellow Pine

 **14PFCT8** – Elite Treated and Primed 8'

 **14PFCT10** – Elite Treated and Primed 10'

 **14PFCT12** – Elite Treated and Primed 12'



1 x 6 T&G Flooring

 **16PF2** – #2 Yellow Pine



 **16PFC** – C&Btr. Yellow Pine



PORCH FLOORING







5/4 x 4 T&G Ipe (Premium) Porch Flooring
(net dimensions: 15/16" x 3" face)

-  **544IF8** – Premium Grade IPE 8'
-  **544IF10** – Premium Grade IPE 10'
-  **544IF12** – Premium Grade IPE 12'
-  **544IF14** – Premium Grade IPE 14'
-  **544IF16** – Premium Grade IPE 16'
-  **544IF18** – Premium Grade IPE 18' (limited availability)
-  **544IF20** – Premium Grade IPE 20' (limited availability)



5/4 x 4 T&G Primed Porch Flooring
(net dimensions: 15/16" x 3-1/8" face)

-  **544PWP8** – Elite Treated® and Primed 8'
-  **544PWP10** – Elite Treated® and Primed 10'
-  **544PWP12** – Elite Treated® and Primed 12'
-  **544PWP14** – Elite Treated® and Primed 14'
-  **544PWP16** – Elite Treated® and Primed 16'

PORCH FLOORING



5/4 x 4 T&G Clear Coated Porch Flooring
(net dimensions: 15/16" x 3-1/8" face)

-  **544CCWP8** – Treated Pine KDAT with One Coat Sealer 8'
-  **544CCWP10** – Treated Pine KDAT with One Coat Sealer 10'
-  **544CCWP12** – Treated Pine KDAT with One Coat Sealer 12'
-  **544CCWP14** – Treated Pine KDAT with One Coat Sealer 14'
-  **544CCWP16** – Treated Pine KDAT with One Coat Sealer 16'



DECKING

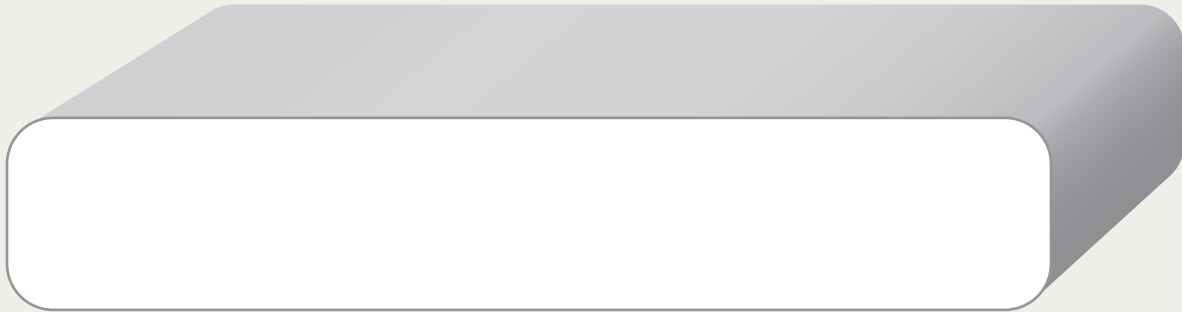

5/4 x 6 Eased Edge Treated Decking
(net dimensions: 1" x 5-1/2")

 **546D10** - #1 Premium Treated KDAT 10'

 **546D12** - #1 Premium Treated KDAT 12'

 **546D12WT** - #2 Wet Treated 12'

 **546D14** - #1 Premium Treated KDAT 14'

 **546D16** - #1 Premium Treated KDAT 16'

 **546D16WT** - #2 Wet Treated 16'



ELITE TREATED[®]
AND PRIMED



YELLOW
PINE



TREATED
PINE



KDAT



FIBERBOARD



FIBER
CEMENT



WESTERN
RED CEDAR



TRU
EXTERIOR



SAPELE



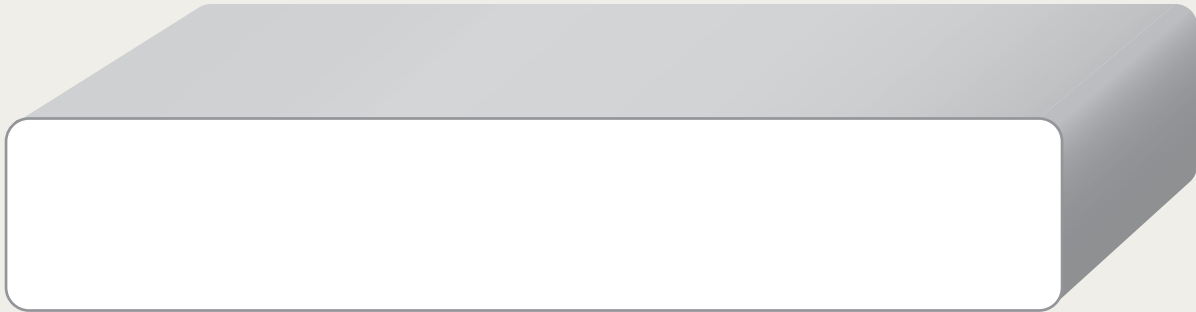

IPE

DECKING





5/4 x 6 (Premium) Eased Edge Decking
(net dimensions: 1" x 5-1/2")

 **1ID4** – Premium Grade IPE 4'

 **1ID5** – Premium Grade IPE 5'

 **1ID6** – Premium Grade IPE 6'

 **1ID8** – Premium Grade IPE 8'

 **1ID10** – Premium Grade IPE 10'

 **1ID12** – Premium Grade IPE 12'

 **1ID14** – Premium Grade IPE 14'

 **1ID16** – Premium Grade IPE 16'

 **1ID18** – Premium Grade IPE 18'

 **1ID20** – Premium Grade IPE 20'



 **1ID22** – Premium Grade IPE 22' (limited availability)



DIMENSIONAL IPE



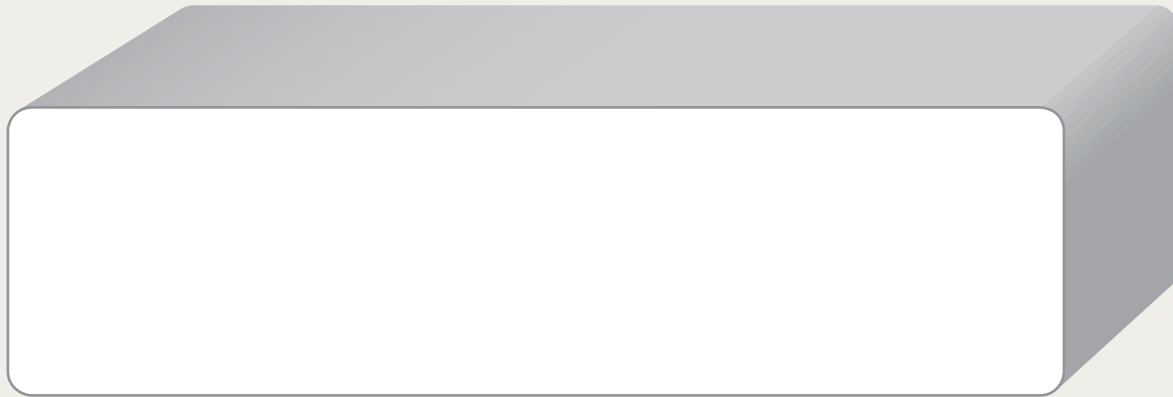

3/4" & 1" S4S Ipe

-  **181** - 1 x 8 Ipe (net dimensions: 3/4" x 7-1/4") shown
-  **5481** - 5/4 x 8 Ipe (net dimensions: 1" x 7-1/4") not shown
-  **54121** - 5/4 X 12 Ipe (net dimensions: 1" x 11-1/4") not shown



1-1/2" S4S Ipe

-  **241** - 2 x 4 Ipe (net dimensions: 1-1/2" x 3-1/2") not shown
-  **261** - 2 x 6 Ipe (net dimensions: 1-1/2" x 5-1/2") shown
-  **2121** - 2 x 12 Ipe (net dimensions: 1-1/2" x 11-1/4") not shown





VISIT OUR Showroom!

- Windows, Doors, and Hardware
- Exterior Finishes and Decking
- Custom Millwork and More!

2031 King Street Extension
Charleston, SC 29405 • 843.744.6281

LOWCOUNTRY LUMBER IMPORTS

*Specialty Imported Hardwoods and Decking
Ipe, Garapa, Purpleheart, and more*

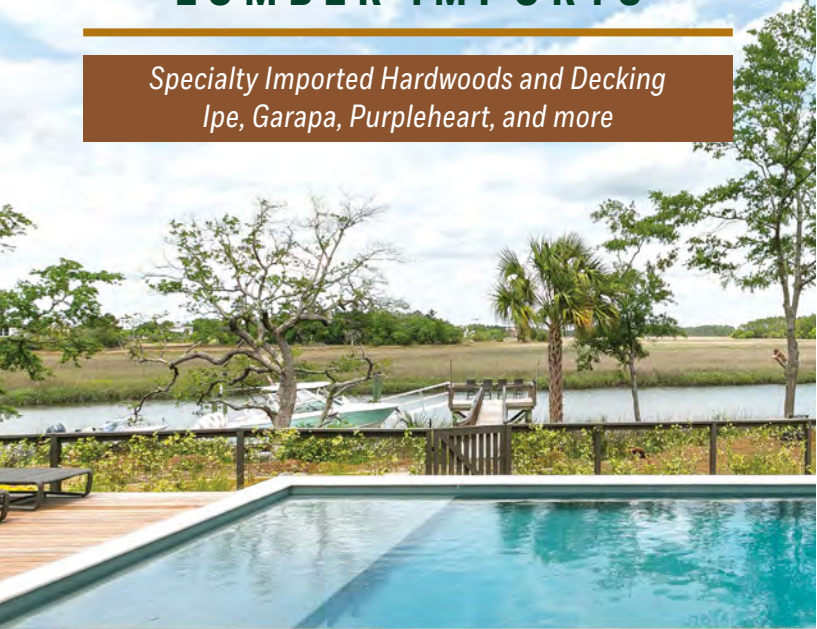

Proud partner of Southern Lumber for 20+ years

843.722.8388

introducing the
SOUTHERN LUMBER APP
— COMING SOON TO ACCOUNT HOLDERS —





ONE BRAND. MANY PRODUCTS.



2X6 DECKING **5/4 DECKING** DECK ACCESSORIES **STEP STRINGERS** LATTICE
MAILBOX POSTS BALUSTERS **HANDRAIL** TURNED SPINDLES **ROOF CANTS**
GRADE STAKES **DIMENSIONAL LUMBER** KDAT **FENCE PANELS** FENCE BOARDS
SPLIT RAIL ROUNDS **SQUARE COLUMNS** TURNED COLUMNS
PRIMED TRIM BOARDS HEAVY TIMBERS **PLYWOOD** PORCH FLOORING
TONGUE & GROOVE CUSTOM MILLING **PILING**

The Trusted Brand in Pressure Treated Lumber
culpeperwood.com

CULPEPER
WOOD PRESERVERS

EXPERIENCE THE *Southern* DIFFERENCE

EXTERIOR RAILS

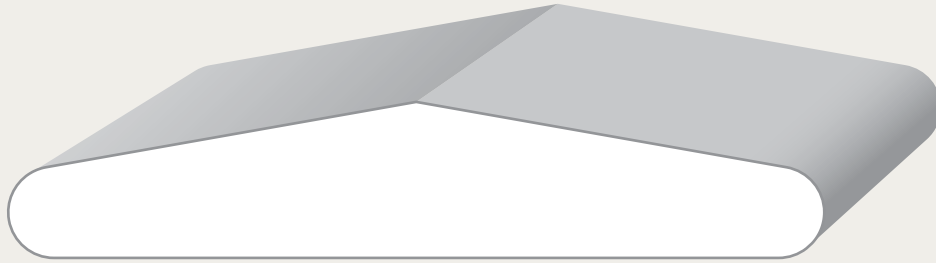

4-1/4" Porch Rail Cap



PRCT8 - Elite Treated® and Primed 8'



PRCT10 - Elite Treated® and Primed 10'



PRCT12 - Elite Treated® and Primed 12'

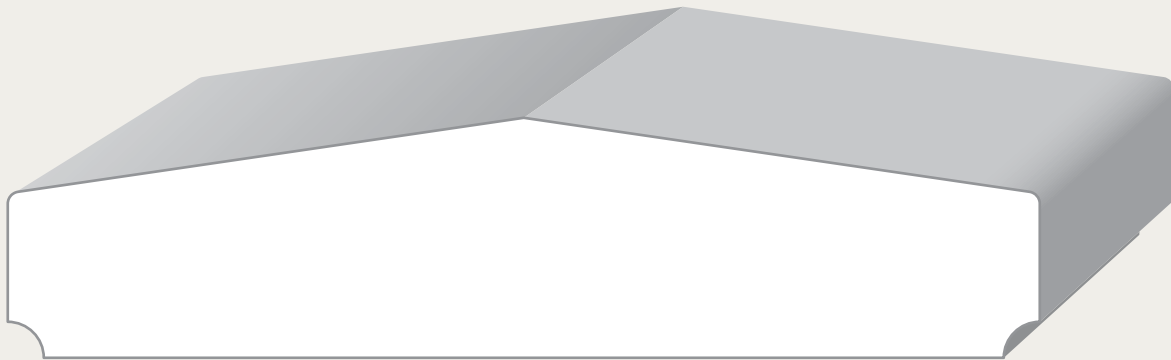

5-3/8" Large Porch Rail Cap



LPRCS8 - Sapele 8'



LPRCS10 - Sapele 10'



LPRCS12 - Sapele 12'



EXTERIOR RAILS

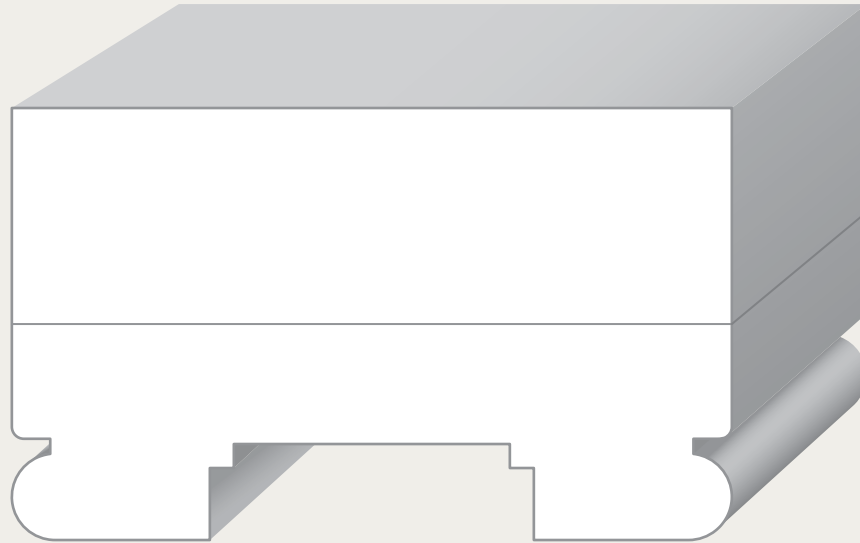
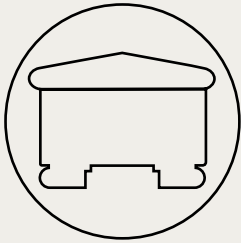

Flat Top Rail For 1-1/2" & 1-5/8" Balusters



TTRF1128 - Laminated Elite Treated® and Primed 8'



TTRF11210 - Laminated Elite Treated® and Primed 10'



TTRF11212 - Laminated Elite Treated® and Primed 12'

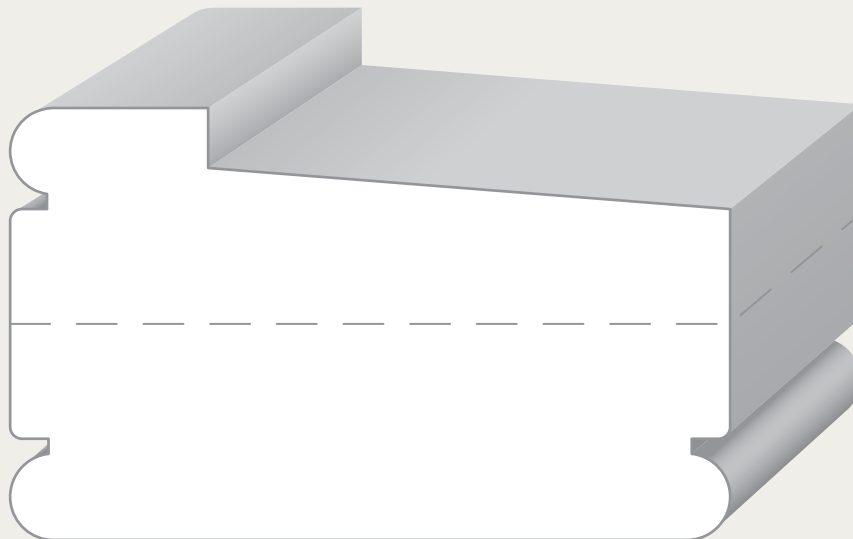

Bottom Rail For 1-1/2" & 1-5/8" Balusters



TBR1128 - Laminated Elite Treated® and Primed 8'



TBR11210 - Laminated Elite Treated® and Primed 10'



TBR11212 - Laminated Elite Treated® and Primed 12'



ELITE TREATED®
AND PRIMED



YELLOW
PINE



TREATED
PINE



HARDIEPLANK



ALLURA



WESTERN
RED CEDAR



POPLAR



SAPELE



IPE

EXTERIOR RAILS

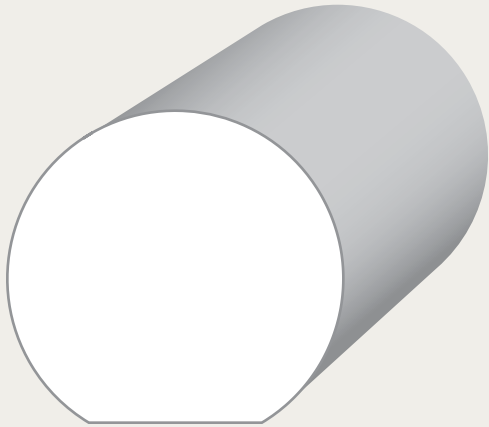

1-3/4" x 1-5/8" Profile 6040
Exterior Stair Rail

 **6040T**

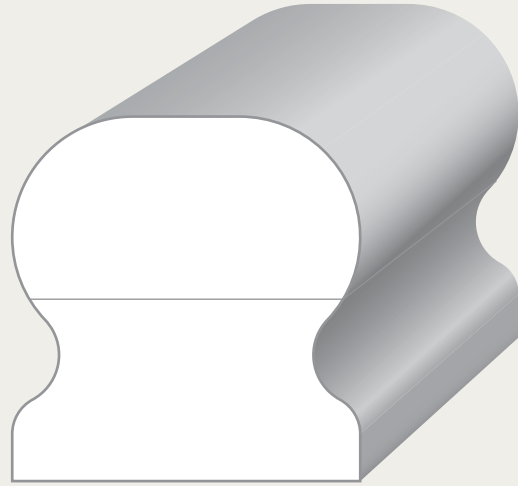

2" Exterior Stair Rail
(net dimensions: 1-13/16" x 1-7/8")

 **2ESRT** – Laminated Treated Pine

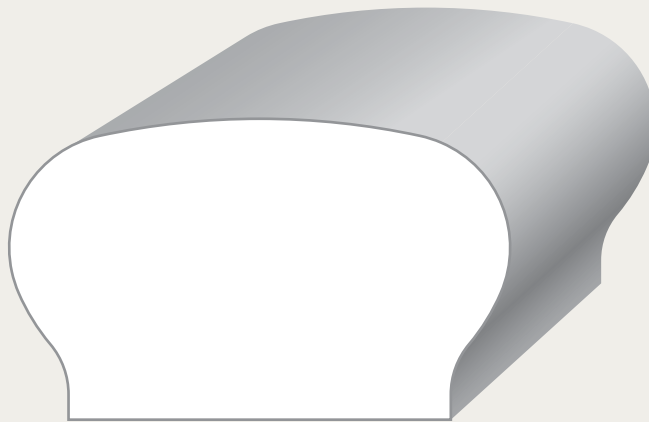

2-5/8" x 1-9/16" Exterior Stair Rail





 **258ESRT**

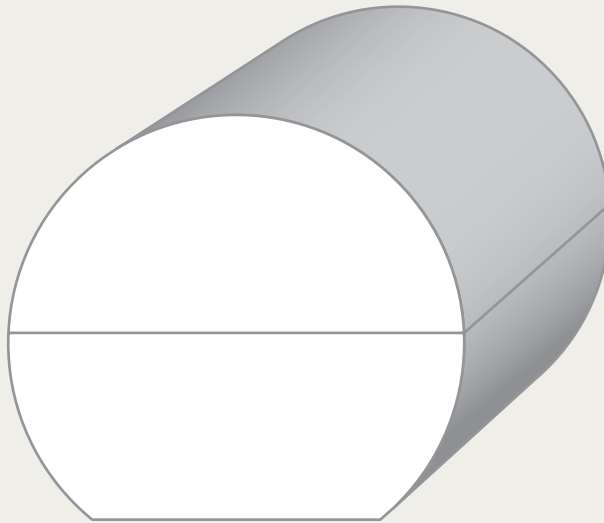

EXTERIOR RAILS



2-3/8" x 2" Exterior Stair Rail

-  **238ESRS** - *Laminated Sapele*
-  **238ESRSQT** - *Sapele Level Quarter*
-  **238ESRSUE** - *Sapele 60° Upeasing*
-  **238ESRSOE** - *Sapele 60° Overeasing*

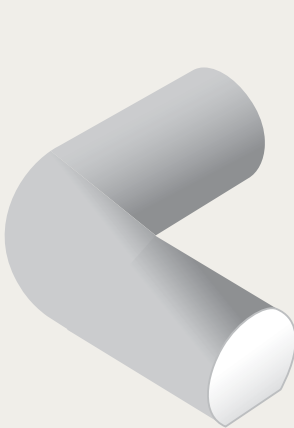

238ESRSQT

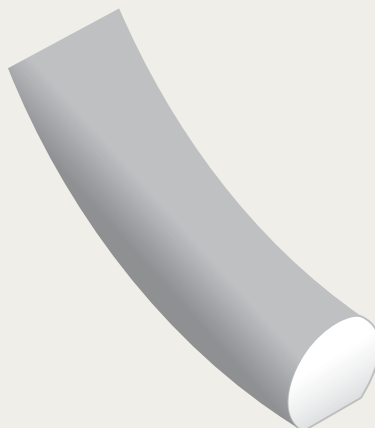

238ESRSUE



238ESRSOE



TREATED BALUSTERS

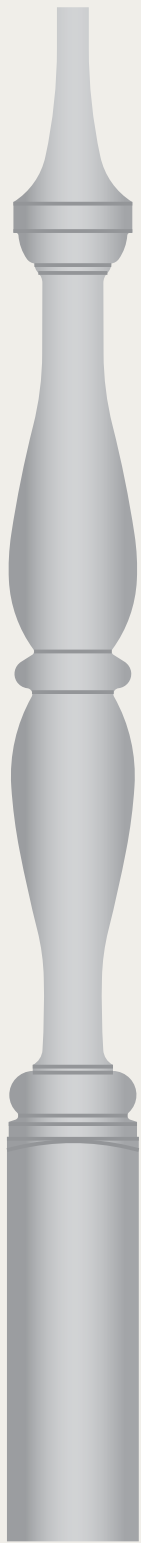

Turned Area
23-9/16"

 ***234LCB**
Lowcountry – 2-3/4" x 32"

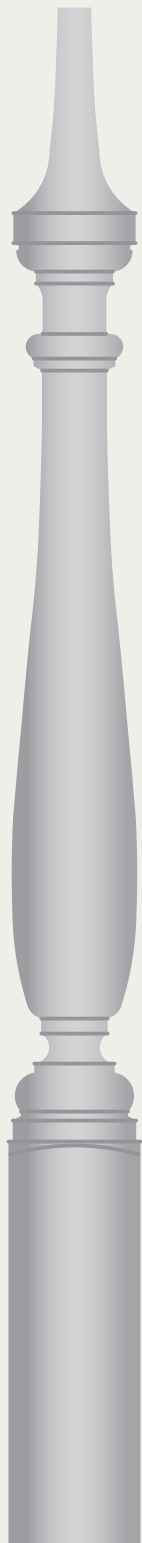

Turned Area
23-5/8"

 ***234PTB**
Point Top – 2-3/4" x 32"



Turned Area
23-3/8"

 ***VB32**
Victorian – 2-3/4" x 32"

* Drawings shown at 1/4 scale



TREATED BALUSTERS



Turned Area
19"

 ***234TB32**
Square Top Colonial – 2-3/4" x 32"

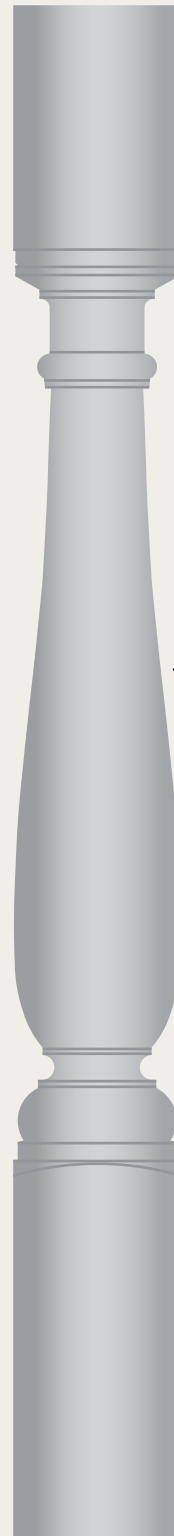

Turned Area
19"

 ***312TB32**
Square Top Colonial – 3-1/2" x 32"

* Drawings shown at 1/4 scale



ELITE TREATED[®]
AND PRIMED



YELLOW
PINE



TREATED
PINE



HARDIEPLANK



ALLURA



WESTERN
RED CEDAR



POPLAR



SAPELE



IPE

TREATED BALUSTERS



2 x 2 Clear Treated Balusters
(net dimensions: 1-1/2" x 1-1/2")

 **22TP3** – Treated Pine Picket 3'

 **2280D** – Treated Pine 8'

 **22120D10** – Treated Pine 12' (10pk)



2 x 2 Primed Balusters
(net dimensions: 1-5/8" x 1-5/8")

 **2230DP** – Elite Treated® and Primed 3'

 **2280DP** – Elite Treated® and Primed 8'

 **22120DP** – Elite Treated® and Primed 12'



POST CAPS



Newport High Pyramid
(fits 3-1/2" net x 3-1/2" net posts)

 *NC1



Newport High Pyramid
(fits 5-1/2" net x 5-1/2" net posts)

 *NC1E

* Drawings shown at 1/2 scale



ELITE TREATED[®]
AND PRIMED



YELLOW
PINE



TREATED
PINE



HARDIEPLANK



ALLURA



WESTERN
RED CEDAR



POPLAR



SAPELE



IPE

POST CAPS



Newport Classic
(fits 3-1/2" net x 3-1/2" net posts)

🔺 *NC2

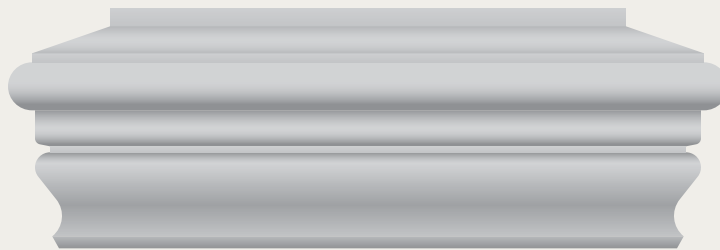

Newport Classic
(fits 5-1/2" net x 5-1/2" net posts)

🔺 *NC2E

* Drawings shown at 1/2 scale



POST CAPS

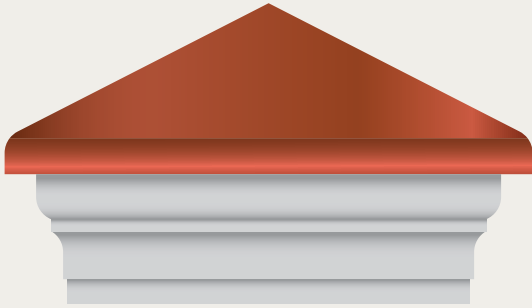

Victoria High Point
(fits 3-1/2" net x 3-1/2" net posts)

🔺 ***VC1** – Copper Top with Western Red Cedar Trim

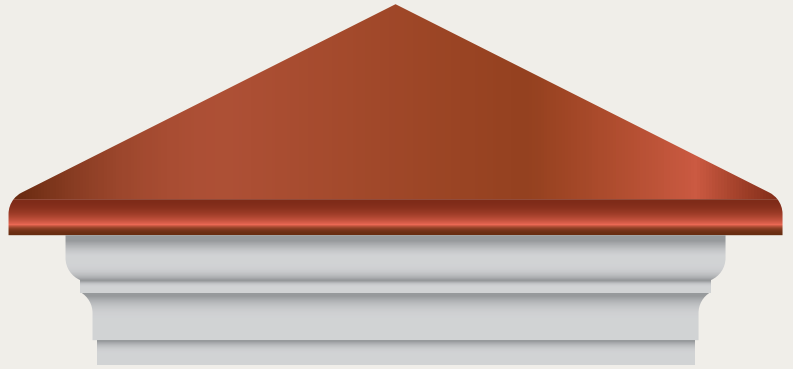

Victoria High Point
(fits 5-1/2" net x 5-1/2" net posts)

🔺 ***VC1E** – Copper Top with Western Red Cedar Trim

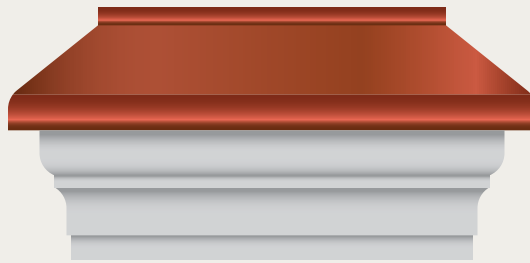

Victoria High Plateau
(fits 3-1/2" net x 3-1/2" net posts)

🔺 ***VC2** – Copper Top with Western Red Cedar Trim

* Drawings shown at 1/2 scale



ELITE TREATED
AND PRIMED



YELLOW
PINE



TREATED
PINE



KDAT



FIBERBOARD



FIBER
CEMENT



WESTERN
RED CEDAR



TRU
EXTERIOR



PRIMED



PVC

POST CAPS

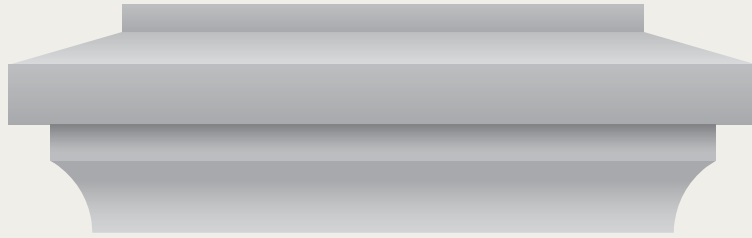

PVC Flat Post Cap
(fits 5-1/2" net x 5-1/2" net posts)

★ IA512



PVC Pyramid Post Cap
(fits 5-1/2" net x 5-1/2" net posts)

★ FA512

* Drawings shown at 1/2 scale



POST CAPS

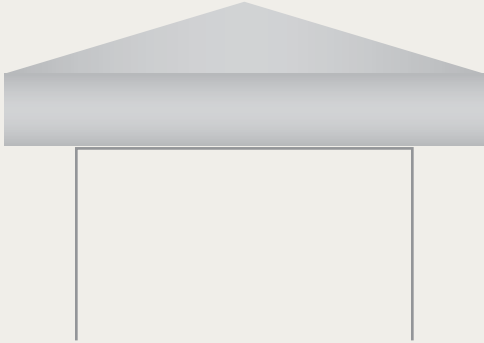

Pyramid Post Cap
(fits 3-1/2" net x 3-1/2" net posts)

 ***SL4SPC**

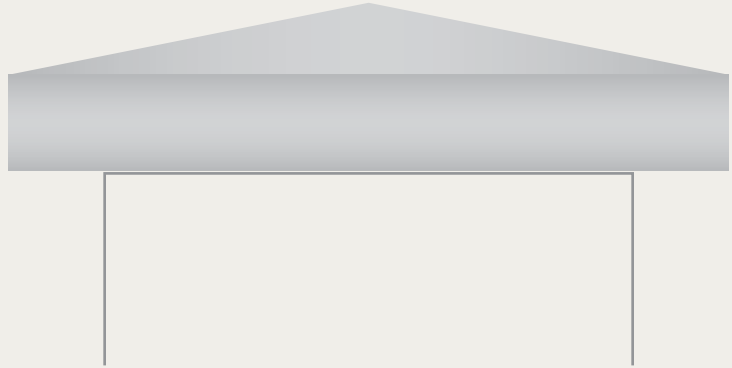

Pyramid Post Cap
(fits 5-1/2" net x 5-1/2" net posts)

 ***SL6SPC**

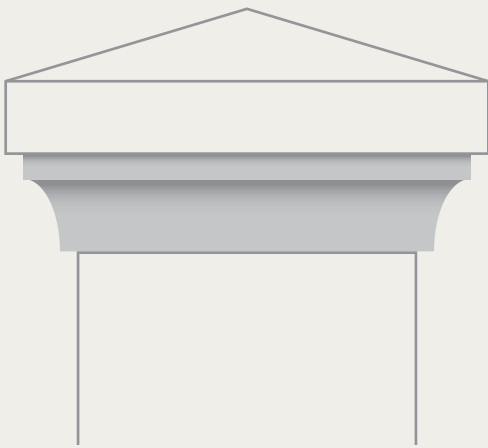

Pyramid Post Cap Base
(fits 3-1/2" net x 3-1/2" net posts)

 ***SL4SPCB**



Pyramid Post Cap Base
(fits 5-1/2" net x 5-1/2" net posts)

 ***SL6SPCB**

* Drawings shown at 1/2 scale



ELITE TREATED[®]
AND PRIMED



YELLOW
PINE



TREATED
PINE



RED
OAK



PRIMED
FJ PINE



MDF
PRIMED



POPLAR



SAPELE



PVC



FLEX
MOULDING

Why Southern Lumber chooses Carolina Machine Finishing



We have been a partner with Carolina Machine Finishing since the day they opened twenty plus years ago.

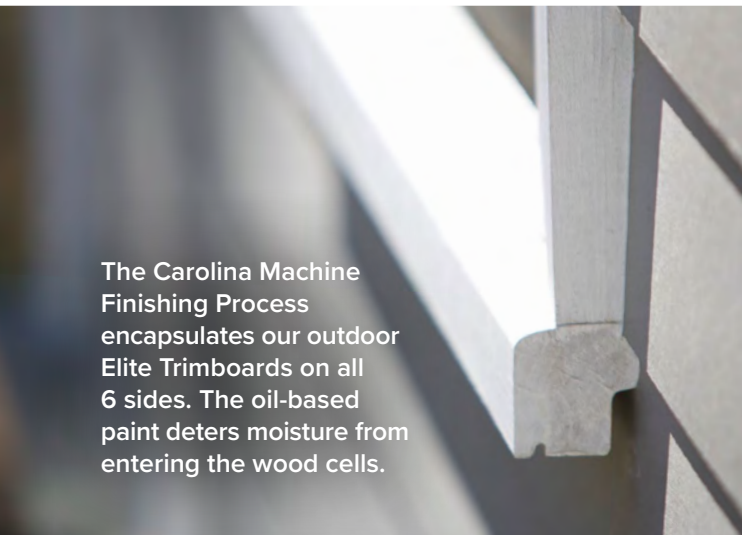

The Carolina Machine Finishing Process encapsulates our outdoor Elite Trimboards on all 6 sides. The oil-based paint deters moisture from entering the wood cells.

Carolina Machine Finishing is committed to supplying superior products to their customers throughout the South. They have been able to ensure a high quality product that is a first choice for contractors, homeowners and architects alike. It's a proven success story.

Protect the exterior of your home from the sun and weather. Add an additional layer of protection with a painting warranty of up to 25 years on most exterior surfaces.

SPECIALIZING IN:

- * Cedar, Cypress, Garapa, Pine & More
- * Fibered Cement Shingles, Siding & Trim
- * Cedar Shake Panels
- * PVC Trim & Decking
- * Composite Trim



843.768.1229

Carolina Machine Finishing Co.

4696 Franch Street, Charlotte

Sustainability.
Longevity.
Reliability.



When it comes to beauty and peace of mind, nothing compares to Elite Treated®. Exterior application with an interior finish and built to last.



S4S (EXTERIOR USE)



3/4" Net Cellular PVC Trimboards

- ★ **344CPVC** - 3/4" x 3-1/2" x 18'
- ★ **346CPVC** - 3/4" x 5-1/2" x 18' (shown)
- ★ **348CPVC** - 3/4" x 7-1/4" x 18'
- ★ **3410CPVC** - 3/4" x 9-1/4" x 18'
- ★ **3412CPVC** - 3/4" x 11-1/4" x 18'
- ★ **3416CPVC** - 3/4" x 15-1/4" x 18'



1" Net Cellular PVC Trimboards

- ★ **544CPVC** - 1" x 3-1/2" x 18'
- ★ **546CPVC** - 1" x 5-1/2" x 18' (shown)
- ★ **548CPVC** - 1" x 7-1/4" x 18'
- ★ **5410CPVC** - 1" x 9-1/4" x 18'
- ★ **5412CPVC** - 1" x 11-1/4" x 18'

The following cellular PVC trim products also available in stock:



- ★ **34WTS** - 3/4" x 4' x 8' CPVC trim sheet



S4S (EXTERIOR USE)







3/4" Fiber Cement Exterior Trim

-  **14SHT** - 3/4" x 3-1/2" x 12' Allura™
-  **16SHT** - 3/4" x 5-1/2" x 12' Allura™ (shown)
-  **18SHT** - 3/4" x 7-1/4" x 12' Allura™
-  **110SHT** - 3/4" x 9-1/4" x 12' Allura™
-  **112SHT** - 3/4" x 11-1/4" x 12' Allura™



3/4" Boral TruExterior® Trim (Reversible)





- ~~ **14SBT** - 3/4" x 3-1/2" Boral TruExterior® Trim 16'~~
- ~~ **16SBT** - 3/4" x 5-1/2" Boral TruExterior® Trim 16' (shown)~~
- ~~ **18SBT** - 3/4" x 7-1/4" Boral TruExterior® Trim 16'~~
- ~~ **110SBT** - 3/4" x 9-1/4" Boral TruExterior® Trim 16'~~
- ~~ **112SBT** - 3/4" x 11-1/4" Boral TruExterior® Trim 16'~~



S4S (EXTERIOR USE)







1" Fiber Cement Exterior Trim

-  **544SHT** - 1" x 3-1/2" x 12' Allura™
-  **546SHT** - 1" x 5-1/2" x 12' Allura™ (shown)
-  **548SHT** - 1" x 7-1/4" x 12' Allura™
-  **5410SHT** - 1" x 9-1/4" x 12' Allura™
-  **5412SHT** - 1" x 11-1/4" x 12' Allura™



1" Boral TruExterior® Trim (Reversible)

-  **544SBT** - 1" x 3-1/2" Boral TruExterior® Trim 16'
-  **546SBT** - 1" x 5-1/2" Boral TruExterior® Trim 16' (shown)
-  **548SBT** - 1" x 7-1/4" Boral TruExterior® Trim 16'
-  **5410SBT** - 1" x 9-1/4" Boral TruExterior® Trim 16'
-  **5412SBT** - 1" x 11-1/4" Boral TruExterior® Trim 16'



S4S (EXTERIOR USE)



1 x 6 Boral TruExterior® Nickel Gap (3/4" x 5-5/64" Reveal)

~~X~~ **16SBNG** - 1" x 6" Boral TruExterior® Nickel Gap 16'

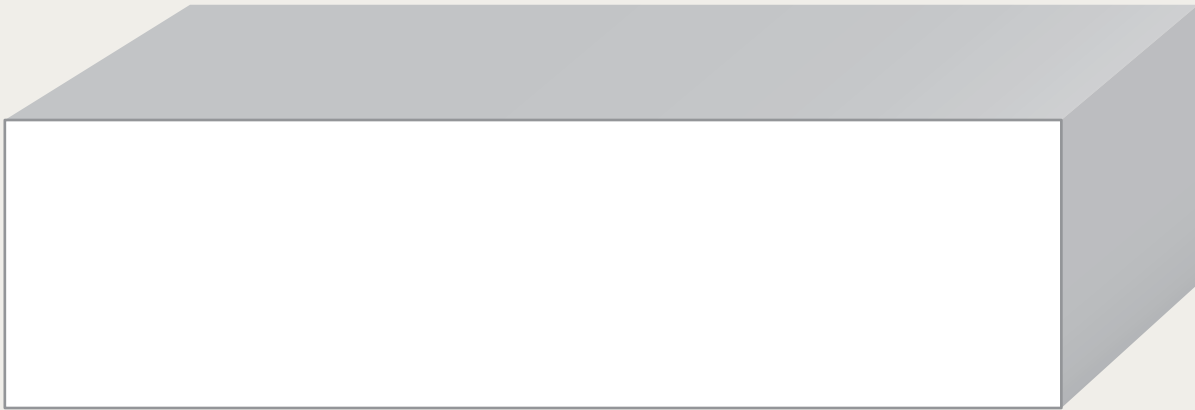

1-1/2" Boral TruExterior Trim® (Reversible)

~~X~~ **26SBT** - 1-1/2" x 5-1/2" Boral TruExterior® Trim 16' (shown)

~~X~~ **24SBT** - 1-1/2" x 3-1/2" Boral TruExterior® Trim 16'

~~X~~ **28SBT** - 1-1/2" x 7-1/4" Boral TruExterior® Trim 16'

~~X~~ **210SBT** - 1-1/2" x 9-1/4" Boral TruExterior® Trim 16'

~~X~~ **212SBT** - 1-1/2" x 11-1/4" Boral TruExterior® Trim 16'



S4S (EXTERIOR USE)



1 x 4 S4S Elite Treated® and Primed Trim Boards
(net dimensions: 3/4" x 3-1/2")



148PCT – Elite Treated® and Primed 8'



1410PCT – Elite Treated® and Primed 10'



1412PCT – Elite Treated® and Primed 12'



1414PCT – Elite Treated® and Primed 14'



1416PCT – Elite Treated® and Primed 16'



1 x 6 S4S Elite Treated® and Primed Trim Boards
(net dimensions: 3/4" x 5-1/2")



168PCT – Elite Treated® and Primed 8'



1610PCT – Elite Treated® and Primed 10'



1612PCT – Elite Treated® and Primed 12'



1614PCT – Elite Treated® and Primed 14'







1616PCT – Elite Treated® and Primed 16'







S4S (EXTERIOR USE)







1 x 8 S4S Elite Treated® and Primed Trim Boards
(net dimensions: 3/4" x 7-1/4") shown

-  **188PCT** – Elite Treated® and Primed 8'
-  **1810PCT** – Elite Treated® and Primed 10'
-  **1812PCT** – Elite Treated® and Primed 12'
-  **1814PCT** – Elite Treated® and Primed 14'
-  **1816PCT** – Elite Treated® and Primed 16'

1 x 10 S4S Elite Treated® and Primed Trim Boards
(net dimensions: 3/4" x 9-1/4") not shown

-  **1108PCT** – Elite Treated® and Primed 8'
-  **11010PCT** – Elite Treated® and Primed 10'
-  **11012PCT** – Elite Treated® and Primed 12'
-  **11014PCT** – Elite Treated® and Primed 14'
-  **11016PCT** – Elite Treated® and Primed 16'

1 x 12 S4S Elite Treated® and Primed Trim Boards
(net dimensions: 3/4" x 11-1/4") not shown

-  **1128PCT** – Elite Treated® and Primed 8'
-  **11210PCT** – Elite Treated® and Primed 10'
-  **11212PCT** – Elite Treated® and Primed 12'
-  **11214PCT** – Elite Treated® and Primed 14'
-  **11216PCT** – Elite Treated® and Primed 16'

S4S (EXTERIOR USE)

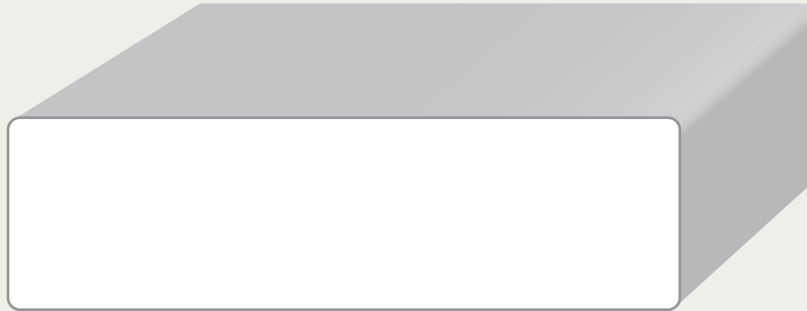

5/4 x 4 S4S Elite Treated® and Primed Trim Boards
(net dimensions: 1" x 3-1/2")



5448PCT – Elite Treated® and Primed 8'



54410PCT – Elite Treated® and Primed 10'



54412PCT – Elite Treated® and Primed 12'



54414PCT – Elite Treated® and Primed 14'



54416PCT – Elite Treated® and Primed 16'



5/4 x 6 S4S Elite Treated® and Primed Trim Boards
(net dimensions: 1" x 5-1/2")



5468PCT – Elite Treated® and Primed 8'



54610PCT – Elite Treated® and Primed 10'



54612PCT – Elite Treated® and Primed 12'



54614PCT – Elite Treated® and Primed 14'



54616PCT – Elite Treated® and Primed 16'



S4S (EXTERIOR USE)



5/4 x 8 S4S Elite Treated® and Primed Trim Boards
(net dimensions: 1" x 6-3/4") shown

-  **5488PCT** – Elite Treated® and Primed 8'
-  **54810PCT** – Elite Treated® and Primed 10'
-  **54812PCT** – Elite Treated® and Primed 12'
-  **54814PCT** – Elite Treated® and Primed 14'
-  **54816PCT** – Elite Treated® and Primed 16'

5/4 x 10 S4S Elite Treated® and Primed Trim Boards
(net dimensions: 1" x 8-3/4") not shown

-  **54108PCT** – Elite Treated® and Primed 8'
-  **541010PCT** – Elite Treated® and Primed 10'
-  **541012PCT** – Elite Treated® and Primed 12'
-  **541014PCT** – Elite Treated® and Primed 14'
-  **541016PCT** – Elite Treated® and Primed 16'

5/4 x 12 S4S Elite Treated® and Primed Trim Boards
(net dimensions: 1" x 10-3/4") not shown

-  **54128PCT** – Elite Treated® and Primed 8'
-  **541210PCT** – Elite Treated® and Primed 10'
-  **541212PCT** – Elite Treated® and Primed 12'
-  **541214PCT** – Elite Treated® and Primed 14'
-  **541216PCT** – Elite Treated® and Primed 16'



ELITE TREATED®
AND PRIMED



YELLOW
PINE



TREATED
PINE



HARDIEPLANK



ALLURA



WESTERN
RED CEDAR



POPLAR



SAPELE



IPE

S4S (EXTERIOR USE)

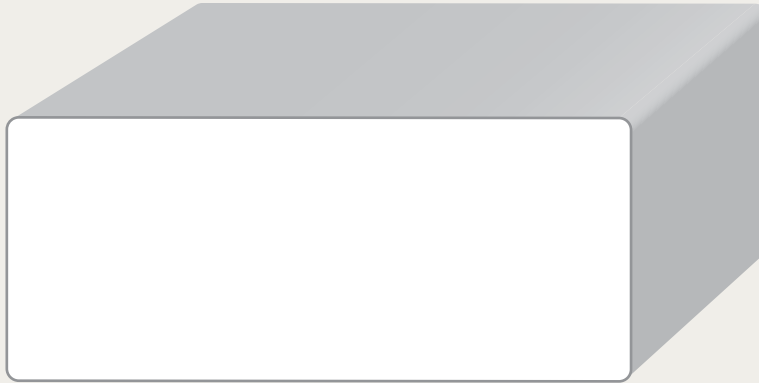

2 x 4 S4S Elite Treated® and Primed Trim Boards – (net dimensions: 1-3/8" x 3-1/4")



2480DP – Elite Treated® and Primed 8'



24100DP – Elite Treated® and Primed 10'



24120DP – Elite Treated® and Primed 12'



24140DP – Elite Treated® and Primed 14'



24160DP – Elite Treated® and Primed 16'



2 x 6 S4S Elite Treated® and Primed Trim Boards – (net dimensions: 1-3/8" x 5-1/4")



2680DP – Elite Treated® and Primed 8'



26100DP – Elite Treated® and Primed 10'



26120DP – Elite Treated® and Primed 12'



26140DP – Elite Treated® and Primed 14'



26160DP – Elite Treated® and Primed 16'



S4S (EXTERIOR USE)



2 x 8 S4S Elite Treated® and Primed Trim Boards
(net dimensions: 1-3/8" x 6-3/4") shown

 **2880DP** – Elite Treated® and Primed 8'

 **28100DP** – Elite Treated® and Primed 10'

 **28120DP** – Elite Treated® and Primed 12'

 **28140DP** – Elite Treated® and Primed 14'

 **28160DP** – Elite Treated® and Primed 16'

2 x 10 S4S Elite Treated® and Primed Trim Boards
(net dimensions: 1-3/8" x 8-3/4") not shown

 **21080DP** – Elite Treated® and Primed 8'

 **210100DP** – Elite Treated® and Primed 10'

 **210120DP** – Elite Treated® and Primed 12'

 **210140DP** – Elite Treated® and Primed 14'

 **210160DP** – Elite Treated® and Primed 16'

2 x 12 S4S Elite Treated® and Primed Trim Boards
(net dimensions: 1-3/8" x 10-3/4") not shown

 **21280DP** – Elite Treated® and Primed 8'

 **212100DP** – Elite Treated® and Primed 10'

 **212120DP** – Elite Treated® and Primed 12'

 **212140DP** – Elite Treated® and Primed 14'

 **212160DP** – Elite Treated® and Primed 16'



ELITE TREATED®
AND PRIMED



YELLOW
PINE



TREATED
PINE



HARDIEPLANK



ALLURA



WESTERN
RED CEDAR



POPLAR



SAPELE



IPE

S4S (EXTERIOR USE)



3 x 6 Treated Laminated Blanks
(net dimensions: 2-5/8" x 5")

-  ***368LAM** – Treated Pine Laminated 8'
-  ***3610LAM** – Treated Pine Laminated 10'
-  ***3612LAM** – Treated Pine Laminated 12'
-  ***3616LAM** – Treated Pine Laminated 16'



3 x 8 Treated Laminated Blanks
(net dimensions: 2-5/8" x 6-3/4")

-  ***388LAM** – Treated Pine Laminated 8'
-  ***3810LAM** – Treated Pine Laminated 10'
-  ***3812LAM** – Treated Pine Laminated 12'
-  ***3816LAM** – Treated Pine Laminated 16'

* Drawings shown at 1/2 scale



S4S (EXTERIOR USE)

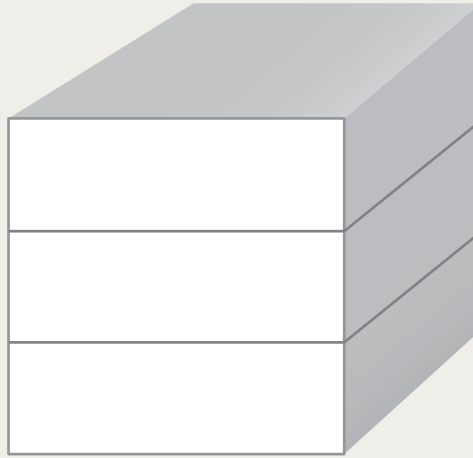

4 x 4 Treated Laminated Blanks
(net dimensions: 3-1/2" x 3-1/2")

 ***312LAM8** - Treated Pine Laminated 8'

 ***312LAM12** - Treated Pine Laminated 12'



3 x 3 Treated Laminated Blanks
(net dimensions: 2-3/4" x 2-3/4")

 **234B8**

* Drawings shown at 1/2 scale



ELITE TREATED[®]
AND PRIMED



YELLOW
PINE



TREATED
PINE



RED
OAK



PRIMED
FJ PINE



MDF
PRIMED



POPLAR



SAPELE



PVC



FIBERBOARD

S4S

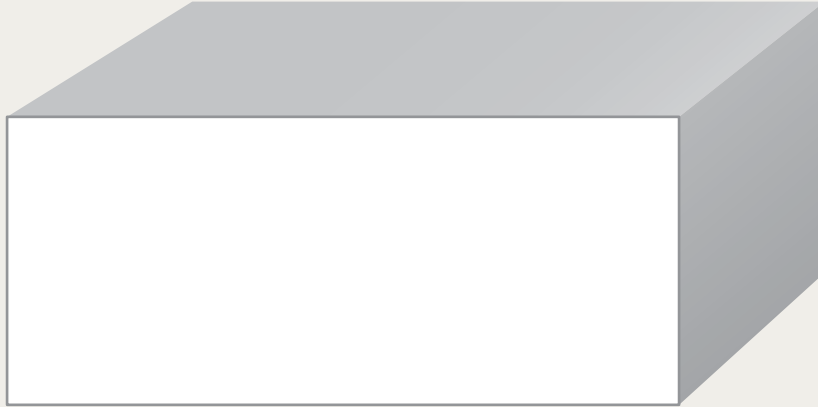

2 x 4 S4S
(net dimensions: 1-1/2" x 3-1/2")

 **24POP** - Poplar

 **24SAP** - Sapele

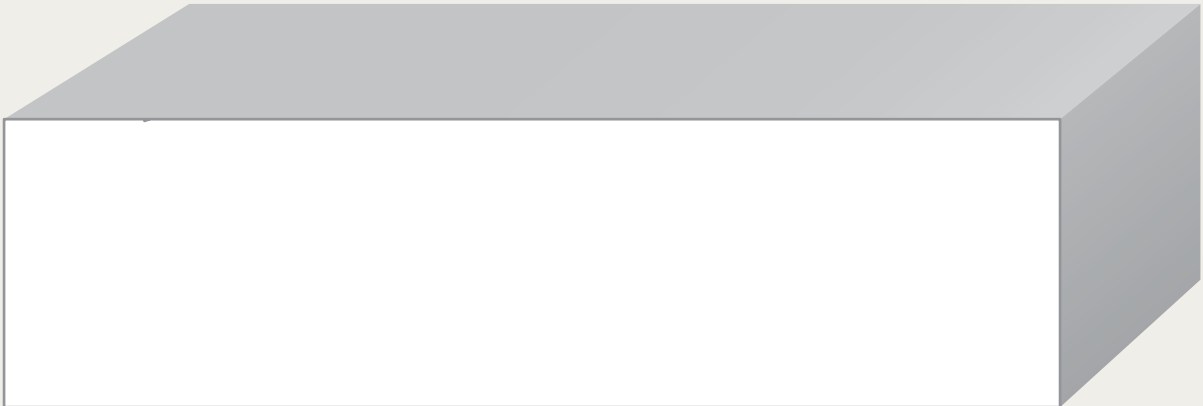

2 x 6 S4S
(net dimensions: 1-1/2" x 5-1/2")

 **26POP** - Poplar

 **26SAP** - Sapele



S4S

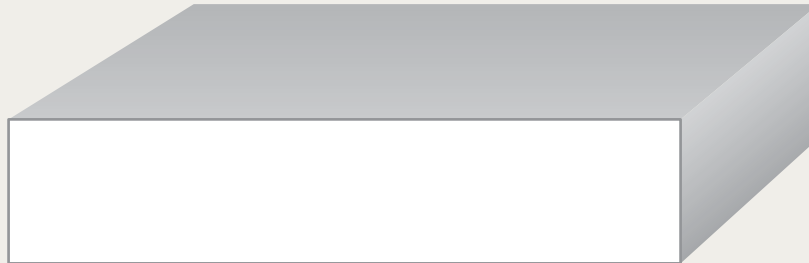

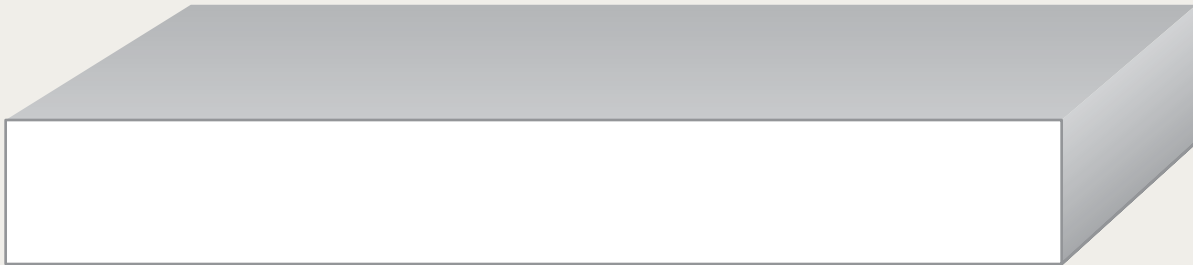

1 x 4 S4S
(net dimensions: 3/4" x 3-1/2")
The following species are available in stock:

-  C&Btr. Yellow Pine
-  Poplar
-  Primed Finger Joint 16'
-  Sapele



1 x 6 S4S
(net dimensions: 3/4" x 5-1/2")
The following species are available in stock:

-  C&Btr. Yellow Pine
-  Poplar
-  Primed Finger Joint 16'
-  Sapele



ELITE TREATED[®]
AND PRIMED



YELLOW
PINE



TREATED
PINE



RED
OAK



PRIMED
FJ PINE



MDF
PRIMED



POPLAR



SAPELE



PVC



FIBERBOARD

S4S



1 x 8 S4S (net dimensions: 3/4" x 7-1/4") shown
The following species are available in stock:

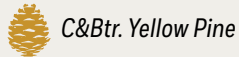

1 x 10 S4S (net dimensions: 3/4" x 9-1/4") not shown
The following species are available in stock:

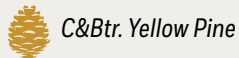

1 x 12 S4S (net dimensions: 3/4" x 11-1/4") not shown
The following species are available in stock:

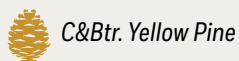



S4S



5/4 x 4 S4S (net dimensions: 1" x 3-1/2") not shown
The following species are available in stock:

 **544CYP** - C&Btr. Yellow Pine

 **544P** - Poplar

 **544FJ** - Primed Finger Joint 16'

5/4 x 6 S4S (net dimensions: 1" x 5-1/4") shown
The following species are available in stock:

 **546CYP** - C&Btr. Yellow Pine

 **546P** - Poplar

 **546FJ** - Primed Finger Joint 16'

5/4 x 8 S4S (net dimensions: 1" x 7-1/4") not shown
The following species are available in stock:

 **548CYP** - C&Btr. Yellow Pine

 **548P** - Poplar

5/4 x 10 S4S (net dimensions: 1" x 9-1/4") not shown
The following species are available in stock:

 **5410P** - Poplar

5/4 x 12 S4S (net dimensions: 1" x 11-1/4") not shown
The following species are available in stock:

 **5412P** - Poplar



S1S2E (SURFACE 1 FACE AND 2 EDGES)

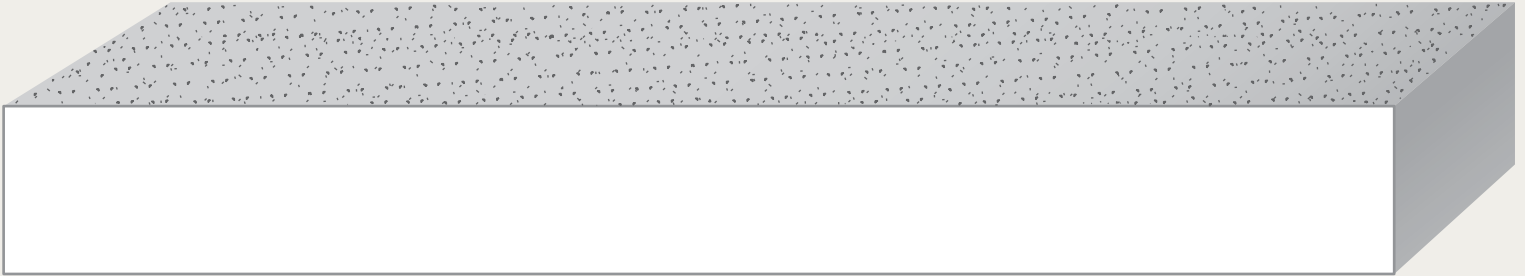

7/8" Cedar S1S2E Select Tight Knot

-  **14S1S2EC** - 1 x 4 Cedar Select Tight Knot
-  **16S1S2EC** - 1 x 6 Cedar Select Tight Knot
-  **18S1S2EC** - 1 x 8 Cedar Select Tight Knot
-  **110S1S2EC** - 1 x 10 Cedar Select Tight Knot
-  **112S1S2EC** - 1 x 12 Cedar Select Tight Knot

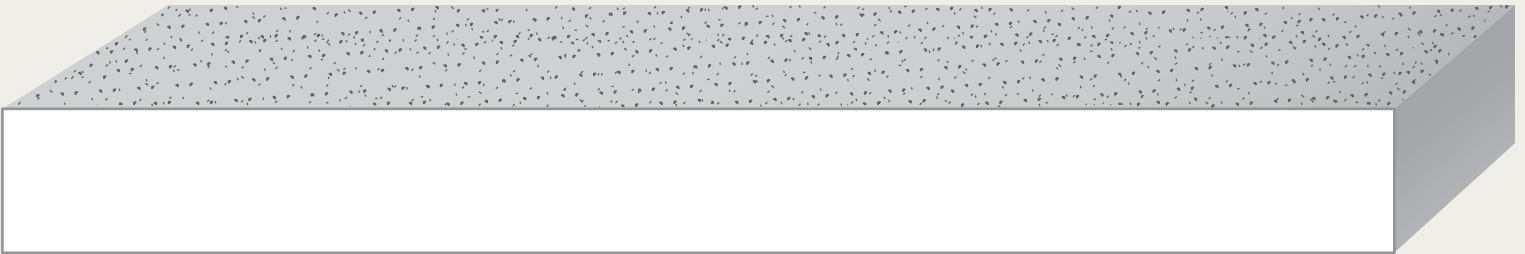

3/4" Cedar S1S2E Select Cypress

-  **14SCS1S** - 1 x 4 Cedar Select Cypress
-  **16SCS1S** - 1 x 6 Cedar Select Cypress
-  **18SCS1S** - 1 x 8 Cedar Select Cypress
-  **110SCS1S** - 1 x 10 Cedar Select Cypress
-  **112SCS1S** - 1 x 12 Cedar Select Cypress



FIBERBOARDS

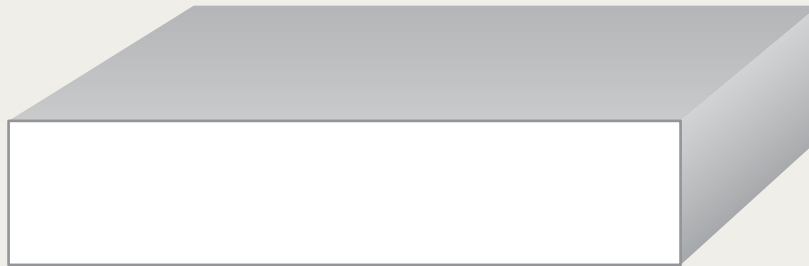

1 x 4 Ultra Lite Fiberboard Primed

 **14UL** – net dimensions: 3/4" x 3-1/2" x 16' (For interior use only)

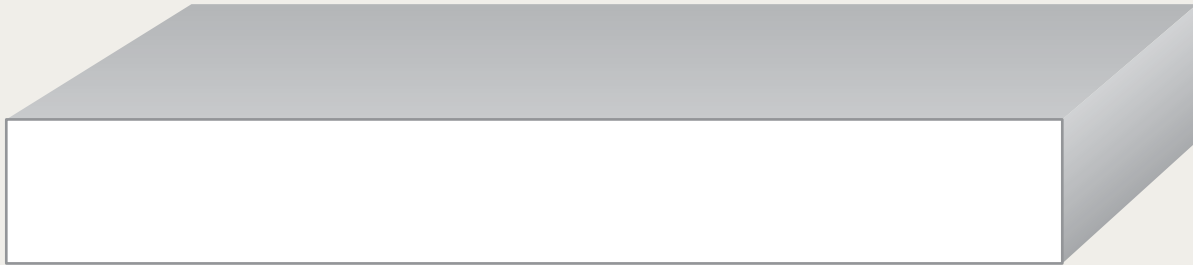

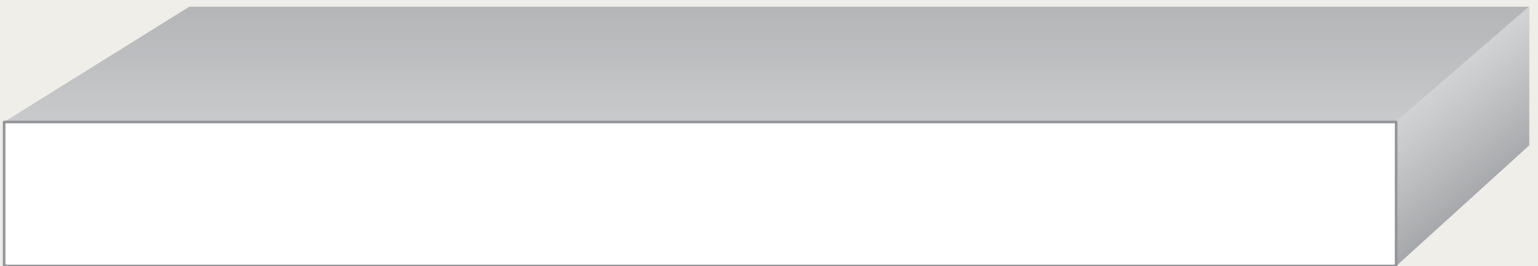

1 x 6 Ultra Lite Fiberboard Primed

 **16UL** – net dimensions: 3/4" x 5-1/2" x 16' (For interior use only)



1 x 8 Ultra Lite Fiberboard Primed

 **18UL** – net dimensions: 3/4" x 7-1/4" x 16' (For interior use only) shown

 **110UL** – net dimensions: 3/4" x 9-1/4" x 16' (For interior use only) not shown

 **112UL** – net dimensions: 3/4" x 11-1/4" x 16' (For interior use only) not shown



ELITE TREATED[®]
AND PRIMED



YELLOW
PINE



TREATED
PINE



KDAT



FIBERBOARD



FIBER
CEMENT



WESTERN
RED CEDAR



TRU
EXTERIOR



PRIMED



PVC

SAPELE SCREEN DOORS

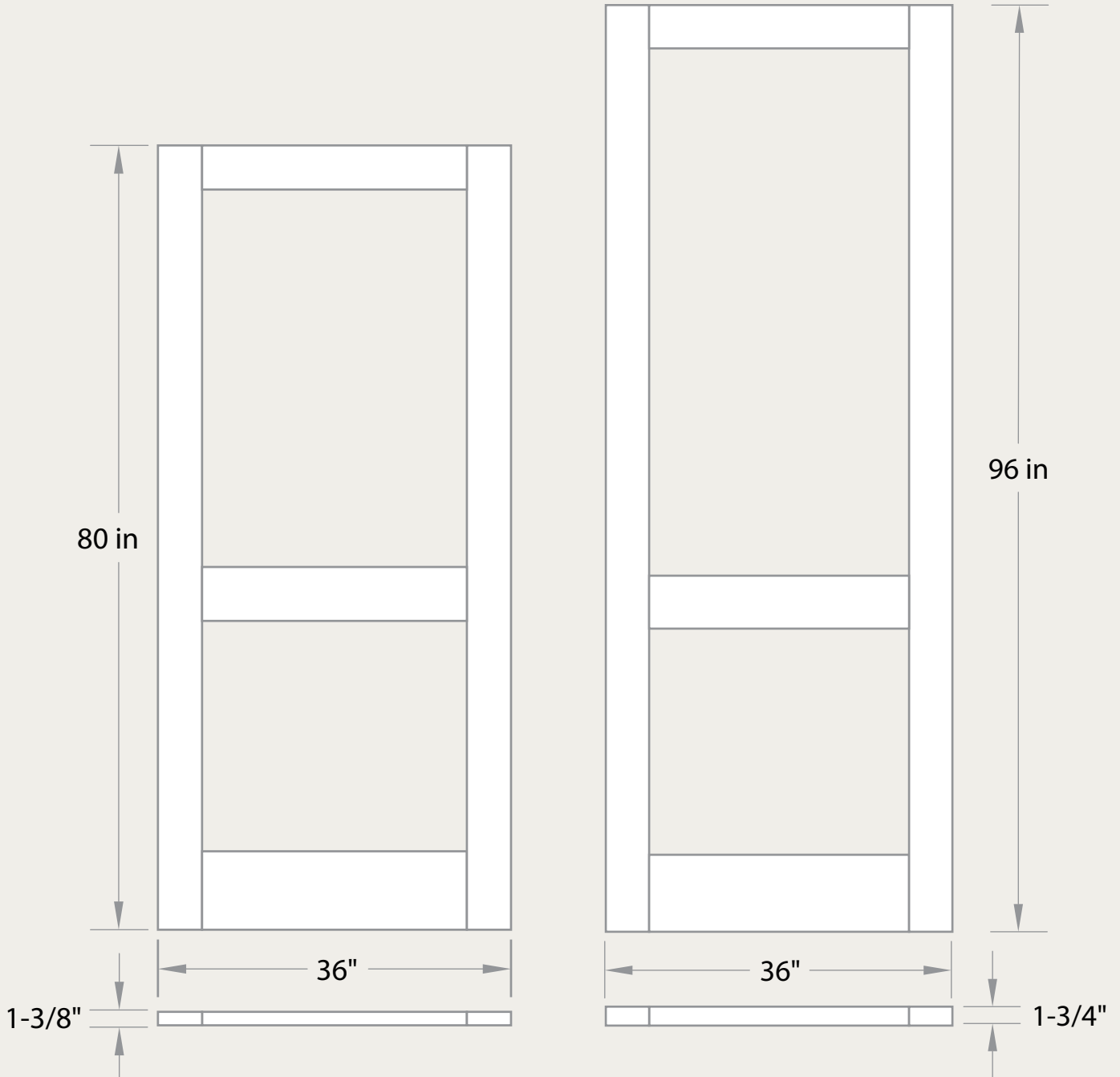

3/0 x 6/8 x 1-3/8 2 Section Sapele Screen Door
(screen not included)

 **30SCSDP**

3/0 x 6/8 x 1-3/4 2 Section Sapele Screen Door
(screen not included)

 **3080SCSDP**



REMOVE THE BOUNDARIES BETWEEN INDOORS AND OUT

Big Doors from Andersen allow you to enjoy spectacular spaces for relaxing, entertaining or just being.



LOVE THE LIFE YOU SEE.™

Learn more at andersenwindows.com/bigdoors

"Andersen" and all other marks where denoted are trademarks of Andersen Corporation. ©2020 Andersen Corporation. All rights reserved



Southern Lumber & Millwork
2031 King Ext
Charleston, South Carolina 29405
843-744-6281
solumber.com

MOULDING PROFILE INDEX

1ID4..... 70	6TGWRY12 60	24SBT 91	544CCWP10..... 68	2412ODP..... 96
1ID5..... 70	6TGWRY14 60	24SHS..... 55	544CCWP12..... 68	2414ODP..... 96
1ID6..... 70	6TGWRY16 60	26POP..... 100	544CCWP14..... 68	2416ODP..... 96
1ID8..... 70	7HSL12 54	26SAP..... 100	544CCWP16..... 68	2610ODP..... 96
1ID10..... 70	7HWL12..... 55	26SBT..... 91	544CPVC..... 88	2612ODP..... 96
1ID12..... 70	7SL12..... 54	28SBT..... 91	544IF8..... 67	2614ODP..... 96
1ID14..... 70	7WL12..... 55	30SCSDP 106	544IF10..... 67	2616ODP..... 96
1ID16..... 70	8SL12..... 54	34WTS..... 88	544IF12..... 67	2810ODP..... 97
1ID18..... 70	8TGCMP8 59	36OT..... 62	544IF14..... 67	2812ODP..... 97
1ID20..... 70	8TGCMP10..... 59	42ORT..... 62	544IF16..... 67	2814ODP..... 97
1ID22..... 70	8TGCMP12..... 59	42OT..... 62	544IF18..... 67	2816ODP..... 97
2ESRT 76	8TGCMP14..... 59	48ORT..... 62	544IF20..... 67	3080SCSDP..... 106
4BVCYP8..... 57	8TGCMP16..... 59	48OT..... 62	544PWP8..... 67	3410CPVC..... 88
4BVCYP10..... 57	8TGWRP8..... 61	54ORT..... 62	544PWP10..... 67	3412CPVC..... 88
4BVCYP12..... 57	8TGWRP10..... 61	110SBT..... 89	544PWP12..... 67	3416CPVC..... 88
4BVCYP14..... 57	8TGWRP12..... 61	110SHT..... 89	544PWP14..... 67	3610LAM..... 98
4BVCYP16..... 57	8TGWRP14..... 61	110UL..... 105	544PWP16..... 67	3612LAM..... 98
4TGB1E..... 58	8TGWRP16..... 61	112SBT..... 89	544SBT..... 90	3616LAM..... 98
4TGVYP8..... 58	8TGWRYP8..... 61	112SHT..... 89	544SHT..... 90	3810LAM..... 98
4TGVYP10..... 58	8TGWRYP10..... 61	112UL..... 105	546CPVC..... 88	3812LAM..... 98
4TGVYP12..... 58	8TGWRYP12..... 61	148PCT..... 92	546D10..... 69	3816LAM..... 98
4TGVYP14..... 58	8TGWRYP14..... 61	168PCT..... 92	546D12..... 69	4095P..... 65
4TGVYP16..... 58	8TGWRYP16..... 61	188PCT..... 93	546D12WT..... 69	5410CPVC..... 88
6BC8 57	8WRCB..... 54	210SBT..... 91	546D14..... 69	5410SBT..... 90
6BC10..... 57	8WRCBP..... 54	212SBT..... 91	546D16..... 69	5410SHT..... 90
6BC12..... 57	12SHS..... 55	223ODP..... 80	546D16WT..... 69	5412CPVC..... 88
6BC14..... 57	12VHS..... 55	228OD 80	546SBT..... 90	5412NCYP..... 62
6BC16..... 57	14PF2..... 66	228ODP..... 80	546SHT..... 90	5412SBT..... 90
6LAPCTP8..... 51	14PFC..... 66	234B8..... 99	548CPVC..... 88	5412SHT..... 90
6LAPCTP10..... 51	14PFCT8..... 66	234LCB..... 78	548SBT..... 90	5448PCT..... 94
6LAPCTP12..... 51	14PFCT10..... 66	234PTB..... 78	548SHT..... 90	5468PCT..... 94
6LAPCTP14..... 51	14PFCT12..... 66	234TB32..... 79	1108PCT..... 93	5488PCT..... 95
6LAPCTP16..... 51	14SBT..... 89	238ESRS..... 77	1128PCT..... 93	6010..... 64
6TGCMP8 59	14SHT..... 89	238ESRSOE..... 77	1410PCT..... 92	6010P8..... 64
6TGCMP10..... 59	14UL..... 105	238ESRSQT..... 77	1412PCT..... 92	6010P10..... 64
6TGCMP12..... 59	16PF2..... 66	238ESRSUE..... 77	1414PCT..... 92	6010P12..... 64
6TGCMP14..... 59	16PFC..... 66	248ODP..... 96	1416PCT..... 92	6010P16..... 64
6TGCMP16..... 59	16SBT..... 89	258ESRT..... 76	1610PCT..... 92	6040..... 63
6TGVYP8..... 58	16SHS..... 55	268ODP..... 96	1612PCT..... 92	6040T..... 76
6TGVYP10..... 58	16SHT..... 89	288ODP..... 97	1614PCT..... 92	6105CTP8..... 52
6TGVYP12..... 58	16TGVP..... 58	312LAM8..... 99	1616PCT..... 92	6105CTP10..... 52
6TGVYP14..... 58	16UL..... 105	312LAM12..... 99	1810PCT..... 93	6105CTP12..... 52
6TGVYP16..... 58	16VHS..... 55	312LAMP..... 65	1812PCT..... 93	6105CTP14..... 52
6TGWRP8 60	18CRC..... 54	312TB32..... 79	1814PCT..... 93	6105CTP16..... 52
6TGWRP10..... 60	18SBT..... 89	344CPVC..... 88	1816PCT..... 93	7011..... 64
6TGWRP12..... 60	18SHT..... 89	346CPVC..... 88	2108ODP..... 97	7012..... 64
6TGWRP14..... 60	18UL..... 105	348CPVC..... 88	2128ODP..... 97	7013..... 64
6TGWRP16..... 60	22TP3..... 80	368LAM..... 98	2212OD10..... 80	8105CTP8..... 52
6TGWRYP8..... 60	24POP..... 100	388LAM..... 98	2212ODP..... 80	8105CTP10..... 52
6TGWRYP10..... 60	24SAP..... 100	544CCWP8..... 68	2410ODP..... 96	8105CTP12..... 52



MOULDING PROFILE INDEX

8105CTP14..... 52	541214PCT..... 95	SL5PCP..... 16	SL103YP..... 40	SL512CPG..... 5
8105CTP16..... 52	541216PCT..... 95	SL6B1EP..... 27	SL106F..... 40	SL514CP..... 6
8143CTP8..... 53	ASHGPNL..... 56	SL6B1EYP..... 27	SL106O..... 40	SL514DB..... 39
8143CTP10..... 53	CWSNT..... 49	SL6HCP..... 4	SL106P..... 40	SL514PGC..... 15
8143CTP12..... 53	EC1..... 22	SL6HCT..... 4	SL106T..... 40	SL514PGCT..... 15
8143CTP14..... 53	EC751..... 25	SL6PCP..... 16	SL106YP..... 40	SL514T..... 6
8143CTP16..... 53	EC10215..... 44	SL6PCT..... 16	SL108YP..... 40	SL558CP..... 5
8145CTP8..... 53	FA512..... 84	SL6PGC..... 15	SL112BT..... 28	SL610P..... 30
8145CTP10..... 53	FJ444..... 23	SL6SPC..... 85	SL112MBP..... 29	SL610YP..... 30
8145CTP12..... 53	HS48..... 55	SL6SPCB..... 85	SL112PGM..... 43	SL618YP..... 31
8145CTP14..... 53	HS410..... 55	SL8B1EP..... 25	SL114PM..... 35	SL620YP..... 31
8145CTP16..... 53	IA512..... 84	SL8B1EYP..... 25	SL118PM..... 35	SL623YP..... 31
11010PCT..... 93	LPRCS8..... 74	SL34BB..... 28	SL120T..... 41	SL810P..... 30
11012PCT..... 93	LPRCS10..... 74	SL34FRP..... 41	SL123YP..... 41	SL810YP..... 30
11014PCT..... 93	LPRCS12..... 74	SL34FRT..... 41	SL134BBP..... 29	SL875P..... 38
11016PCT..... 93	M40P..... 36	SL34NP..... 42	SL138PM..... 35	SL875YP..... 38
11210PCT..... 93	M130P..... 36	SL47P..... 7	SL158BB..... 29	SL935YP..... 38
11212PCT..... 93	MDF45A..... 6	SL47T..... 7	SL158HBB..... 29	SL936YP..... 38
11214PCT..... 93	MDF47..... 7	SL48P..... 8	SL163T..... 33	SL1163P..... 43
11216PCT..... 93	MDF163..... 33	SL49P..... 9	SL166P..... 34	SL1201P..... 33
21010ODP..... 97	MDF505..... 14	SL49T..... 9	SL172P..... 34	SL1207P..... 34
21012ODP..... 97	MDF610..... 30	SL51P..... 10	SL180T8..... 50	SL1207T..... 34
21014ODP..... 97	MDF611..... 30	SL52P..... 11	SL180T10..... 50	SL7503..... 4
21016ODP..... 97	MDF653..... 14	SL54BB..... 28	SL180T12..... 50	SL54212NP..... 42
21210ODP..... 97	NC1..... 81	SL54CT..... 19	SL196T..... 48	SLCSB..... 46
21212ODP..... 97	NC1E..... 81	SL54CYP..... 19	SL203P..... 32	SLLDLDC..... 48
21214ODP..... 97	NC2..... 82	SL54P..... 11	SL205YP..... 36	SLPBS..... 39
21216ODP..... 97	NC2E..... 82	SL54PGBB..... 28	SL207T..... 47	SLPCP..... 19
54108PCT..... 95	PRCT8..... 74	SL54T..... 11	SL210T..... 47	SLSBCP..... 33
54128PCT..... 95	PRCT10..... 74	SL54WS6P..... 45	SL212MBYP..... 24	SLSCM..... 35
54410PCT..... 94	PRCT12..... 74	SL54WS8P..... 45	SL212YP..... 47	SLSCMT..... 35
54412PCT..... 94	PVCBM..... 50	SL66P..... 12	SL214BM..... 47	SLSF..... 34
54414PCT..... 94	SL2BCP..... 32	SL66T..... 12	SL234CT..... 11	SLSO..... 34
54416PCT..... 94	SL2BCWBP..... 32	SL71P..... 13	SL238BCP..... 32	SLSSM..... 46
54610PCT..... 94	SL2CBM..... 51	SL71T..... 13	SL266T..... 46	SLSWCR..... 37
54612PCT..... 94	SL3P..... 22	SL72T..... 13	SL266YP..... 46	SLSYP..... 34
54614PCT..... 94	SL3YP..... 22	SL74P..... 13	SL273P..... 35	SLSYPP..... 34
54616PCT..... 94	SL4B1EP..... 26	SL74T..... 13	SL288P..... 37	SLTWC..... 48
54810PCT..... 95	SL4B1ET..... 26	SL81P..... 17	SL312CT..... 10	SLWS212P..... 44
54812PCT..... 95	SL4B1EYP..... 26	SL81T..... 17	SL312MB..... 21	SLYPBS..... 39
54814PCT..... 95	SL4B2EP..... 26	SL82P..... 18	SL312MBP..... 21	SLYPBST..... 39
54816PCT..... 95	SL4BWB..... 21	SL84P..... 18	SL338BMT..... 49	SLYPBSTL..... 38
80905..... 63	SL4BWBYP..... 21	SL84T..... 18	SL366YP..... 24	TTRF1128..... 75
506042P..... 65	SL4BWCP..... 20	SL85P..... 18	SL4CT..... 8	TTRF11210..... 75
541010PCT..... 95	SL4CPGP..... 9	SL100F..... 19	SL412WBP..... 20	TTRF11212..... 75
541012PCT..... 95	SL4DB..... 39	SL1000..... 19	SL414PCP..... 17	VB32..... 78
541014PCT..... 95	SL4SPC..... 85	SL100T..... 19	SL414PCT..... 17	VC1..... 83
541016PCT..... 95	SL4SPCB..... 85	SL100YP..... 19	SL414T..... 12	VC1E..... 83
541210PCT..... 95	SL5B1EP..... 27	SL101YP..... 19	SL444YP..... 23	VC2..... 83
541212PCT..... 95	SL5B1EYP..... 27	SL103T..... 40	SL453YP..... 24	



ELITE TREATED
AND PRIMED



YELLOW
PINE



TREATED
PINE



RED
OAK



PRIMED
FJ PINE



MDF
PRIMED



POPLAR



SAPELE



PVC



FLEX
MOULDING

EXPERIENCE THE *Southern* DIFFERENCE



2031 KING ST EXT, CHARLESTON SC 29405

CALL (843)744-6281 VISIT SoLUMBER.COM

VOLUME 11